

Defining & Delivering the Future of Mission-Critical Electronics

April 15th, 2024

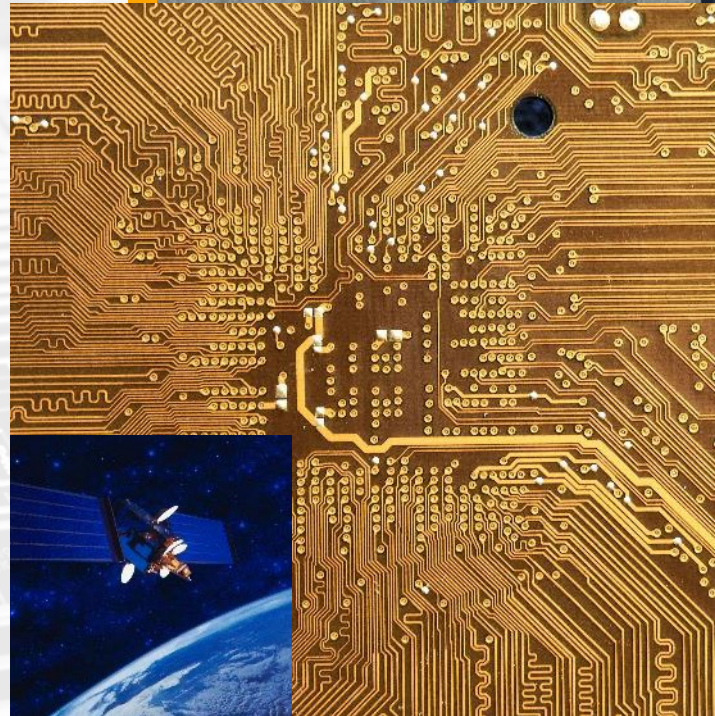

Corporate Overview

Defining & Delivering the Future
of Mission-Critical Electronics

- > Global leader within aerospace, defense and commercial markets

- > 15,000+ products across 16 Business Units

- > 1,500+ customers worldwide

- > ~ 900 employees in 20 locations

- > 60+ years of history serving mission-critical electronics

- > Strong patent and IP position

Three Verticals of Mission-Critical Electronics

RF/MW Products

(Components to Integrated Assemblies)

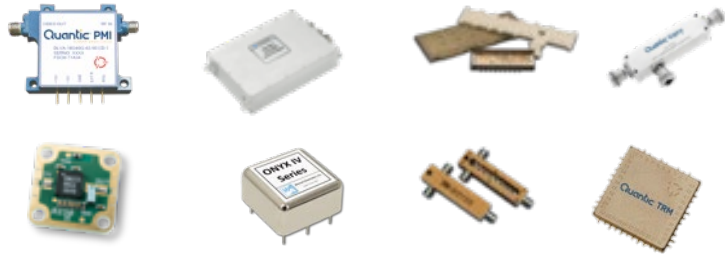

Quantic™ Corry

Quantic™ MWD
MICROWAVE DYNAMICS

Quantic™ TRM

Quantic™ PMI
PLANAR MONOLITHICS

Quantic™ Wenzel

Quantic™ X-Microwave

Quantic™ Croven

Sensing Products

(Encoders, Scanners & Accelerometers)



Quantic™ BEI

Quantic™ Thistle

Power Products

(Capacitors, Resistors & Magnetics)

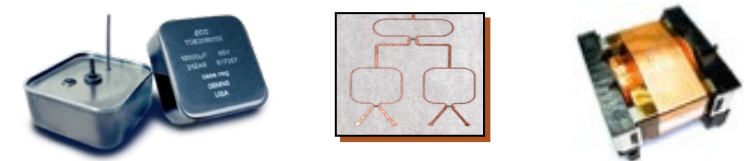

Quantic™ Evans

Quantic™ ECI

Quantic™ Eulex

Quantic™ Ohmega

Quantic™ Paktron

Quantic™ Ticer

Quantic™ UTC

Why Quantic?

A Broad Portfolio of RF, Sensing, and Power Products

Portfolio of 15,000+ Catalog Products and Fully Custom Offerings

- > Crystal Oscillators
- > Encoders & Accelerometers
- > High-Power Capacitors
- > Resistive Foils
- > Magnetics
- > Power Dividers
- > Filters
- > Converters
- > Amplifiers
- > Phase Shifters

Decades of Experience Serving Mission-Critical Programs

COTS to Mil-Spec Capabilities / US and International EAR-99 Compliance

- > Joint Strike Fighter
- > Air & Missile Defense Radar
- > Apple iPhone
- > Key components on medical equipment for Abbott, GE Healthcare & Karl Storz
- > Over 60 years of space pedigree—NASA Orion, Mars Perseverance Rover, SBIRS, and ISS

Serving a Diverse Set of Applications and Customers

Serving Industry Leaders Across All End Markets

- > Aerospace & Defense
- > Commercial
- > Industrial
- > Magnetics
- > Test & Measurement



Small Company Flexibility with Large Company Stability

Engineer-to-engineer "hands on" approach

- > Ability to rapidly prototype w/attractive lead times
- > RF/MW systems optimization capabilities with modular, scalable building blocks
- > Multiple locations for complex problem solving
- > Ability to invest where customers have critical needs

Focused on Components & Modules in the Value Chain

Primes/Tier 1
Mission Integrated Systems

Tier 2
Integrated Subsystems

Tier 3
Modules

Tier 4
Components



Our Focus

Design and Manufacturing Locations

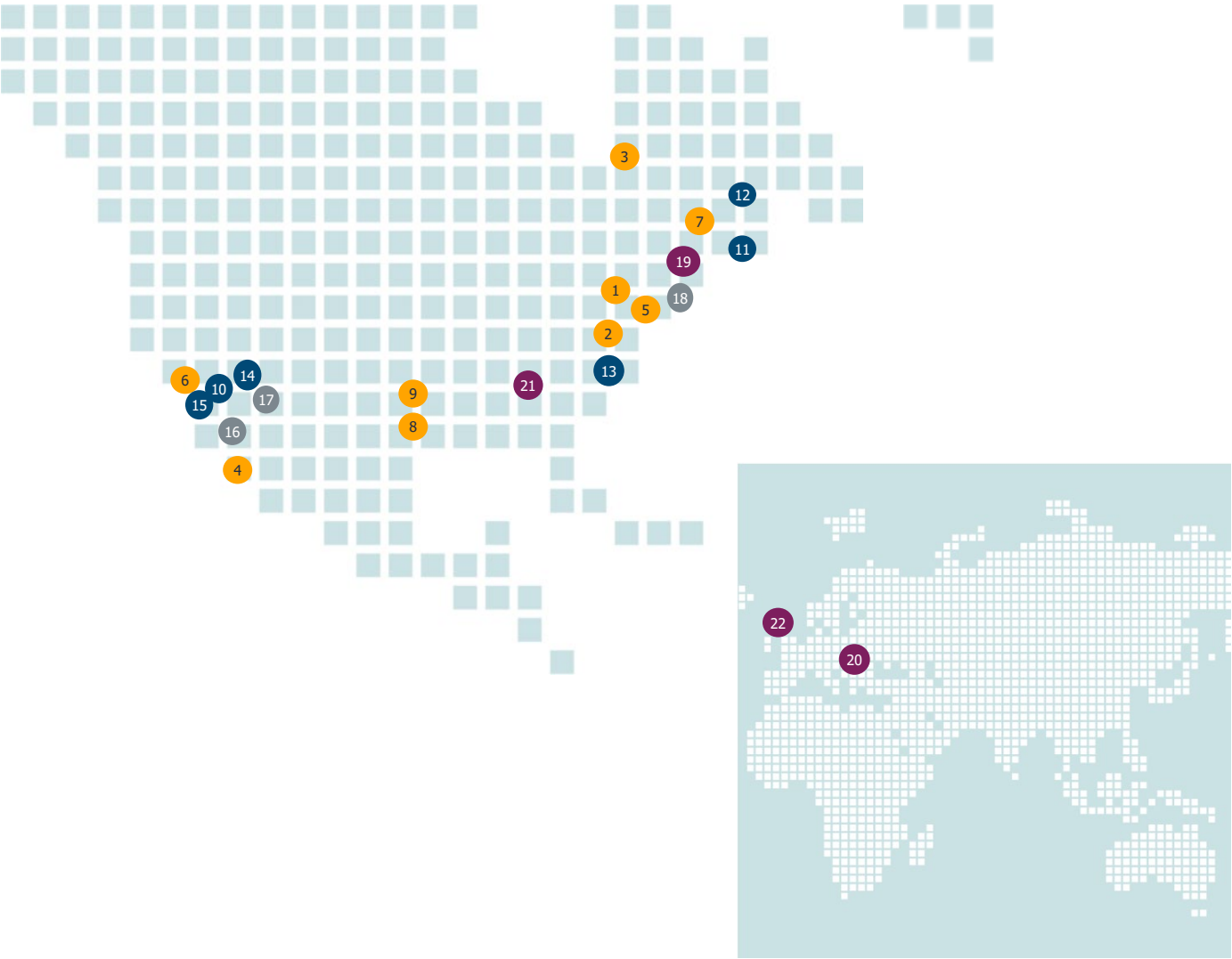

RF & Microwave

- 1 Quantic Corry – Corry, Pennsylvania
- 2 Quantic Corry – Warrendale, Pennsylvania
- 3 Quantic Croven – Whitby, Ontario
- 4 Quantic MWD – Irvine, California
- 5 Quantic PMI – Frederick, Maryland
- 6 Quantic PMI – El Dorado Hills, California
- 7 Quantic TRM – Bedford, New Hampshire
- 8 Quantic Wenzel – Austin, Texas
- 9 Quantic X-Microwave – Austin, Texas

Capacitors

- 10 Quantic Eulex – Monterey Park, California
- 11 Quantic Evans – East Providence, Rhode Island
- 12 Quantic Evans – Sanford, Maine
- 13 Quantic Paktron – Lynchburg, Virginia
- 14 Quantic TPC – Phoenix, Arizona
- 15 Quantic UTC – Monterey Park, California

Resistors

- 16 Quantic Ohmega – Culver City, California
- 17 Quantic Ticer – Chandler, Arizona
- 18 Quantic Ticer – Windsor, Connecticut

Magnetic & Sensing

- 19 Quantic ECI – Westfield, Massachusetts
- 20 Quantic ECI – Tatabanya, Hungary
- 21 Quantic BEI – Maumelle, Arkansas
- 22 Quantic Thistle – Midlothian, Scotland

Business Unit Leadership Team



Jon Crowley
VP & GM, Quantic ECI



Alan Sikarskie
VP & GM, Quantic BEI & Quantic Thistle



Colin McClennan
VP & GM, Quantic Capacitors



Sebastian Palacio
VP & GM, Quantic PMI



Daniel Teuthorn
VP & GM
Quantic X-Microwave



Joe Svoboda
VP & GM, Quantic Wenzel & Quantic MWD



Lisa Wilhelm
VP & GM, Quantic Ohmega & Quantic Ticer

Corporate Support Team



Ross Sealfon
President & CEO



Diane Rothkophf
VP, Strategy and M&A



Tim Glavin
VP, Corp Biz Dev



Joe Salsbury
Chief Financial Officer



Cory King
VP Of Human Resources



Jessen Wehrwein
Chief Marketing Officer

Quantic PMI Overview

Defining & Delivering the Future
of Mission-Critical Electronics

- > Global leader within military, space and commercial markets
- > Design & manufacture of Quality RF & Microwave Components & Integrated Module Assemblies
- > Offers more than 4000 commercial off-the-shelf models with test results, S-parameters, 3D models and detailed specs available.
- > Every product is built to rigorous MIL-STD specs
- > ITAR & ISO-9001 Certifications
- > Industry-leading sales and applications support, leading to lower costs and faster lead times than competitive options.

Design and Manufacturing Locations

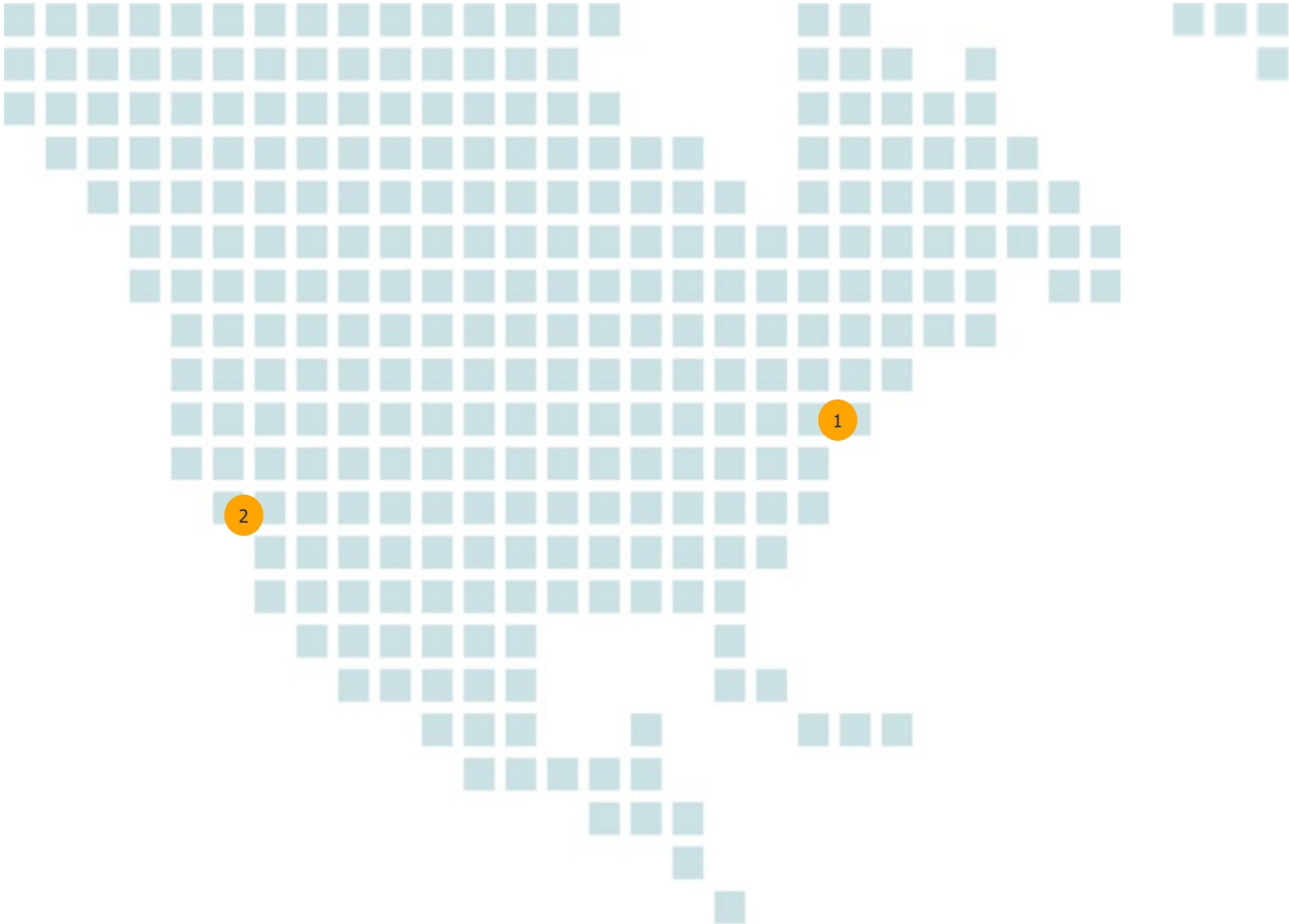

RF & Microwave

- 1 Quantic PMI – Frederick, Maryland
East Coast Operation
7309-A Grove Road
Frederick, MD 21704 USA

Tel: 301.662.5019
Fax: 301.662.1731

- 2 Quantic PMI – EL Dorado Hills, California
West Coast Operation
4921 Robert Mathews PKWY, Suite 1
EL Dorado Hills, CA 95762 USA

TEL: 916.542.1401
FAX: 916.265.2597

sales@quanticpmi.com

www.quanticpmi.com

Milestones & Accreditations

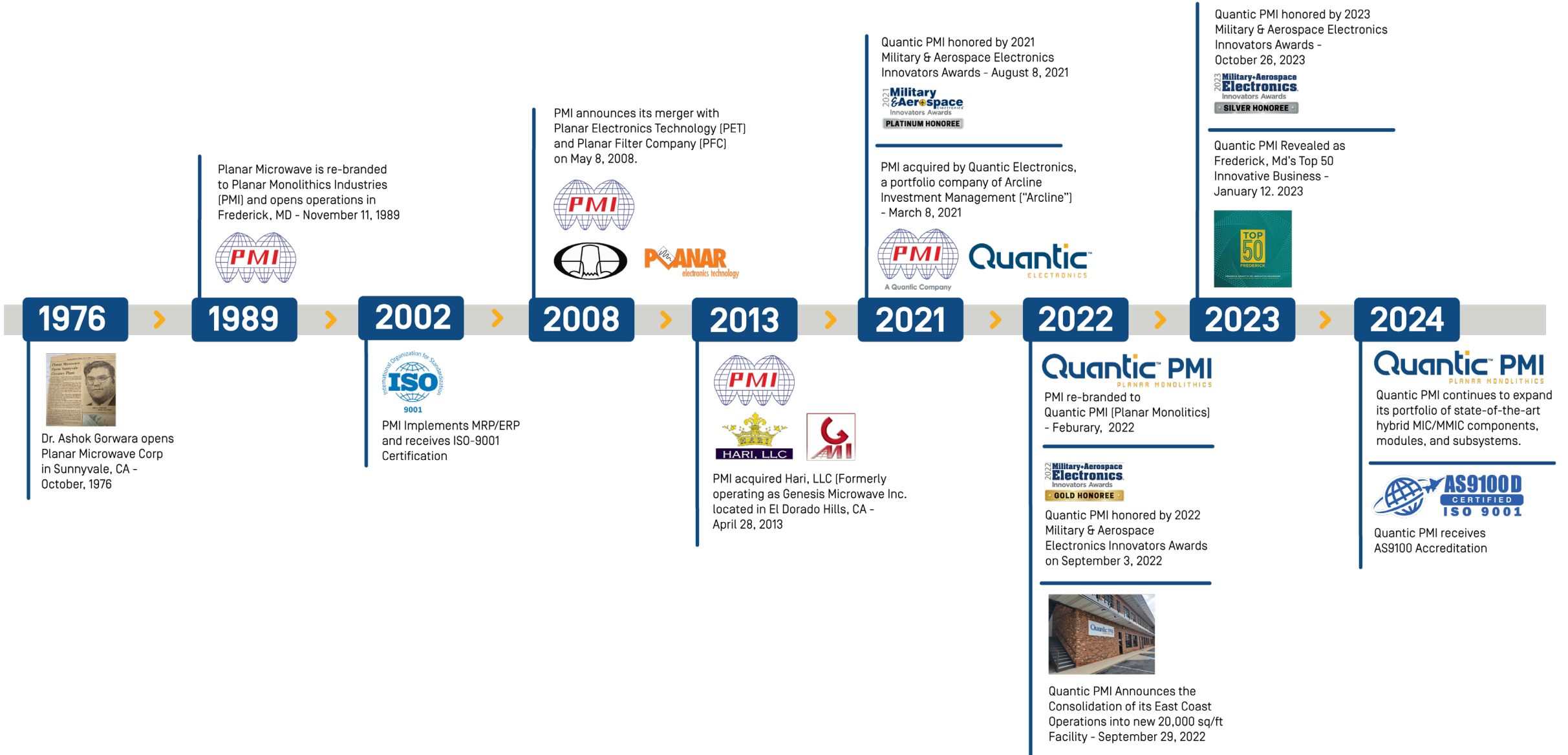

Design & Applications

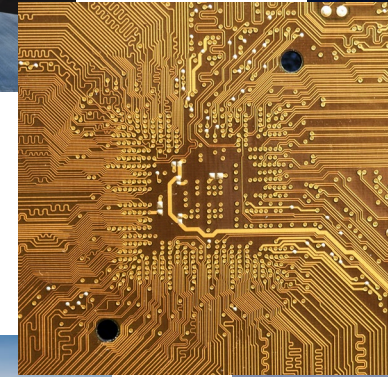
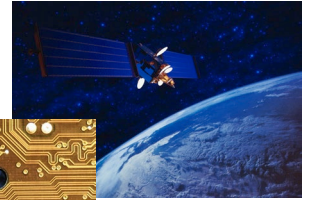

As a manufacturer Quantic PMI utilizes our own designs for all components, integrated modules and subsystems

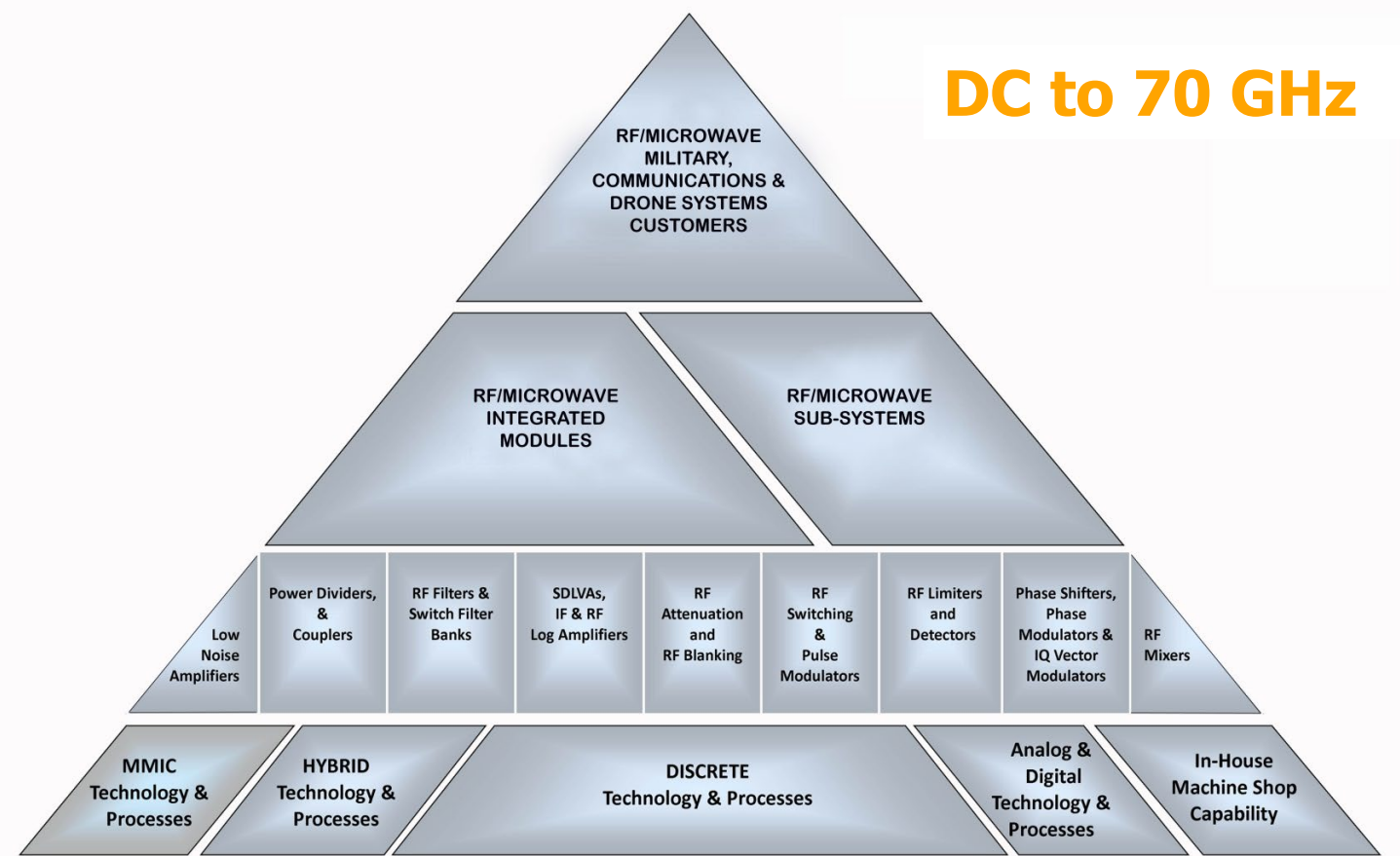

Applications of Quantic PMI Components & Sub-Systems

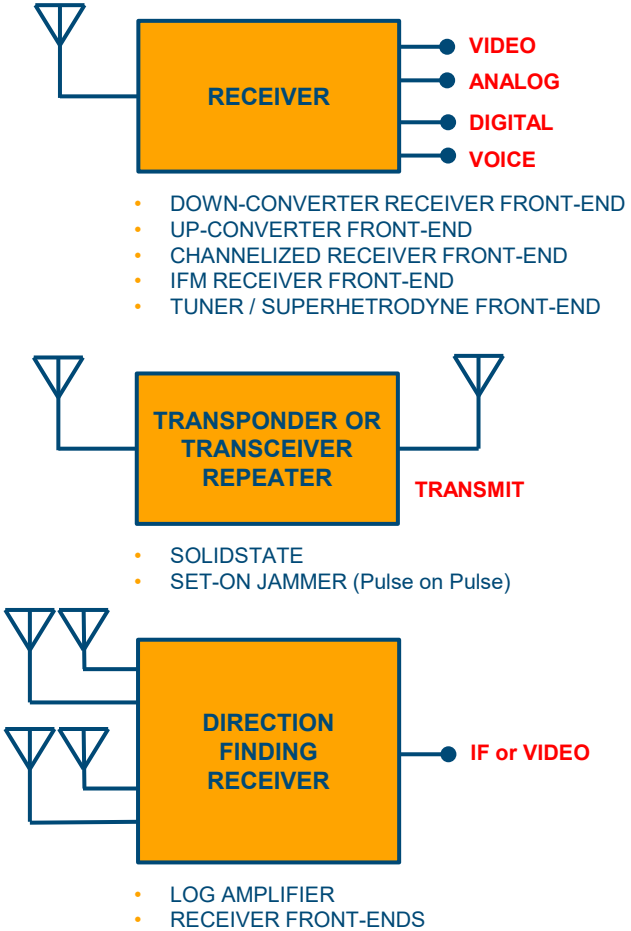

Quantic PMI (Planar Monolithics) has been in business for over 30 years as a world-class designer and manufacturer of electronic components and subsystems for defense applications such as **Receiver Front-Ends, Synthesizers, and Transceivers**. A large variety of **RF components and integrated modules** have been developed to compliment this target market. Our technical goal is to produce the finest products available that resolve this mathematical statement:

$$V_{(input)} = A \cos(\omega_c t + \phi_t)$$

↓
↓
↓

AMPLITUDE FREQUENCY PHASE & MODULATION

TYPICAL EW, ECM, ESM RECEIVER FRONT-END

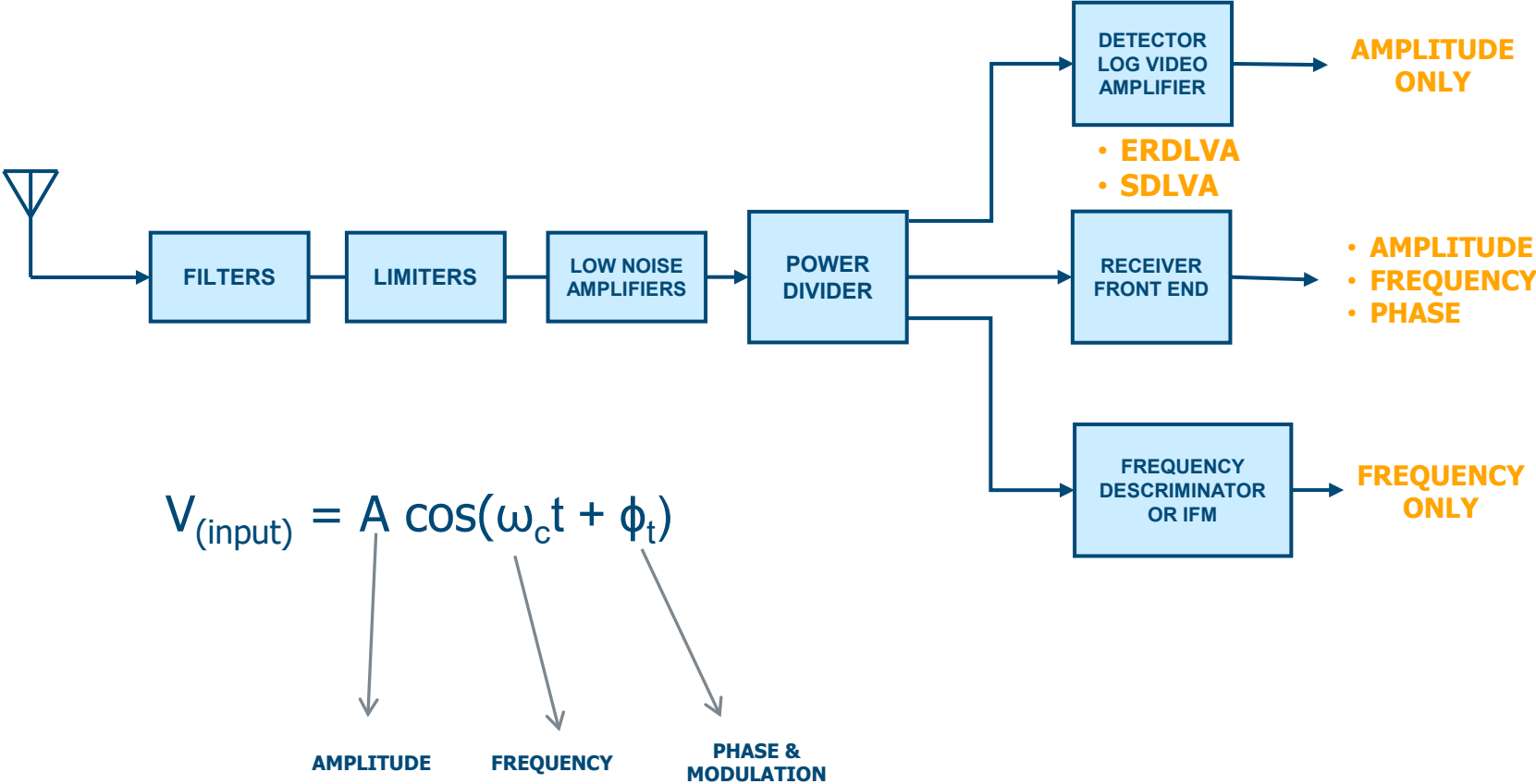

TYPICAL EW, ECM, ESM RECEIVER FRONT-END

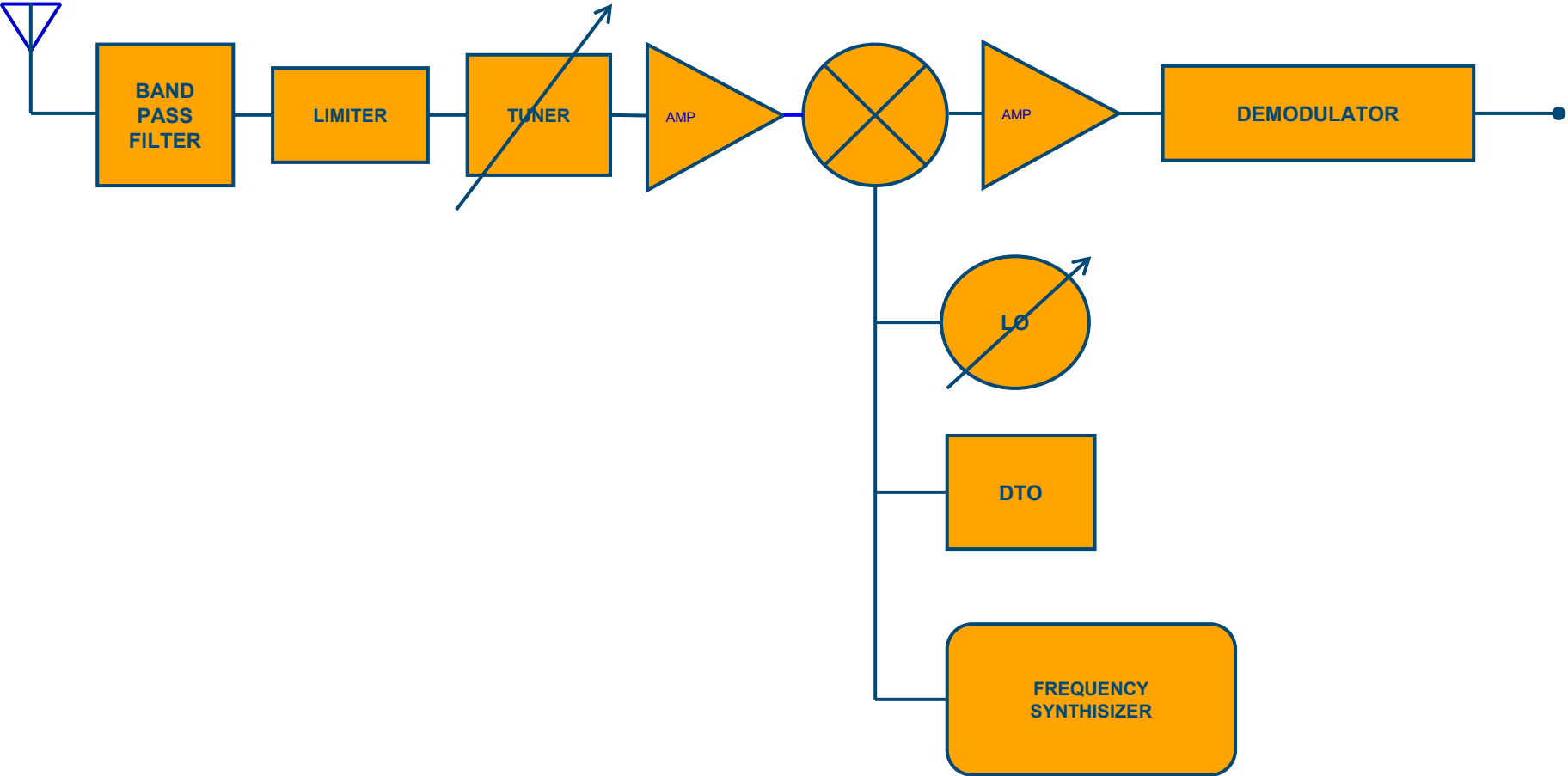

TYPICAL TRANSCEIVER / TRANSPONDER BLOCK DIAGRAM

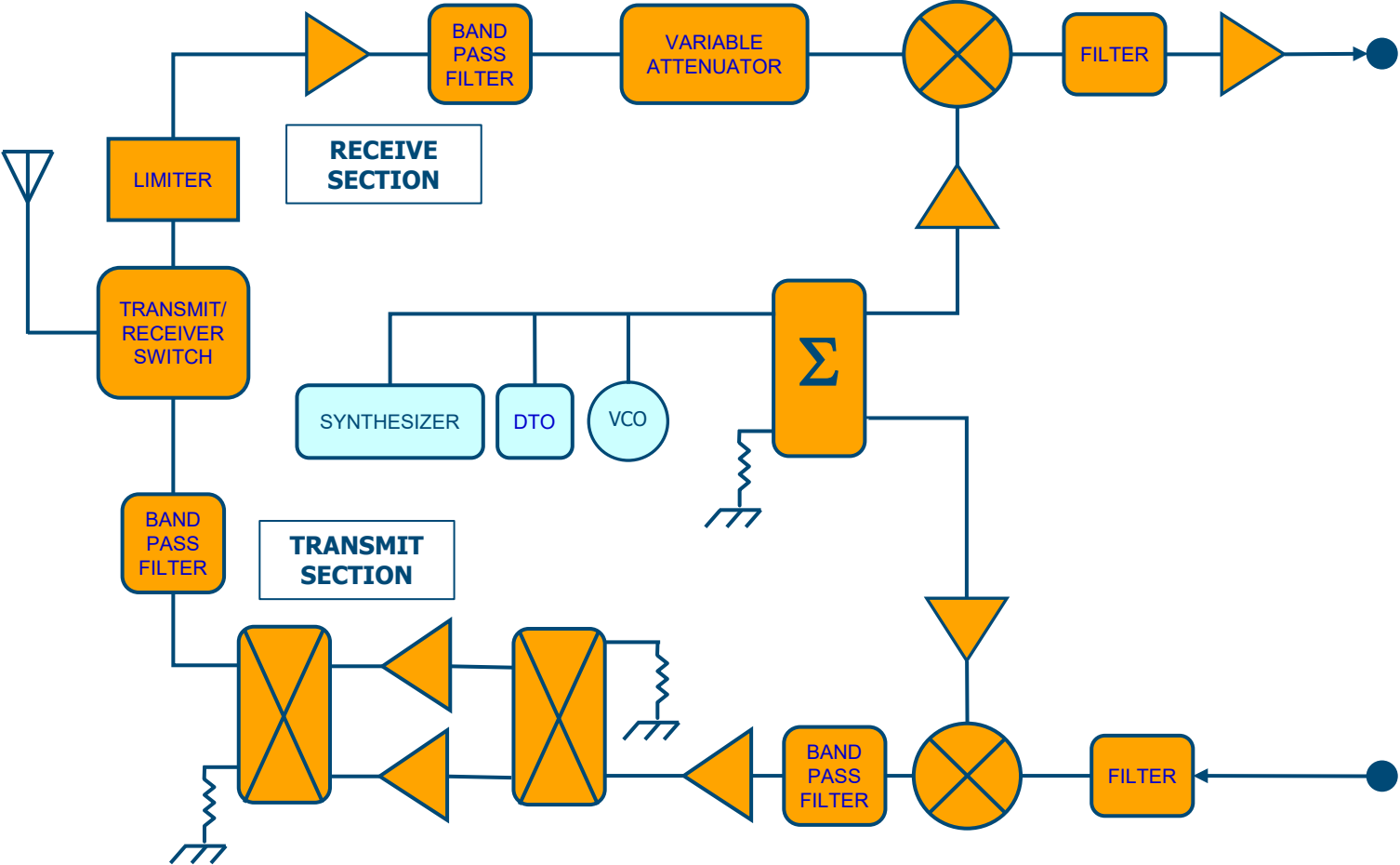

TYPICAL RADAR WARNING RECEIVER FRONT-END OR DIRECTION FINDING RECEIVER FRONT-END SUB-SYSTEM

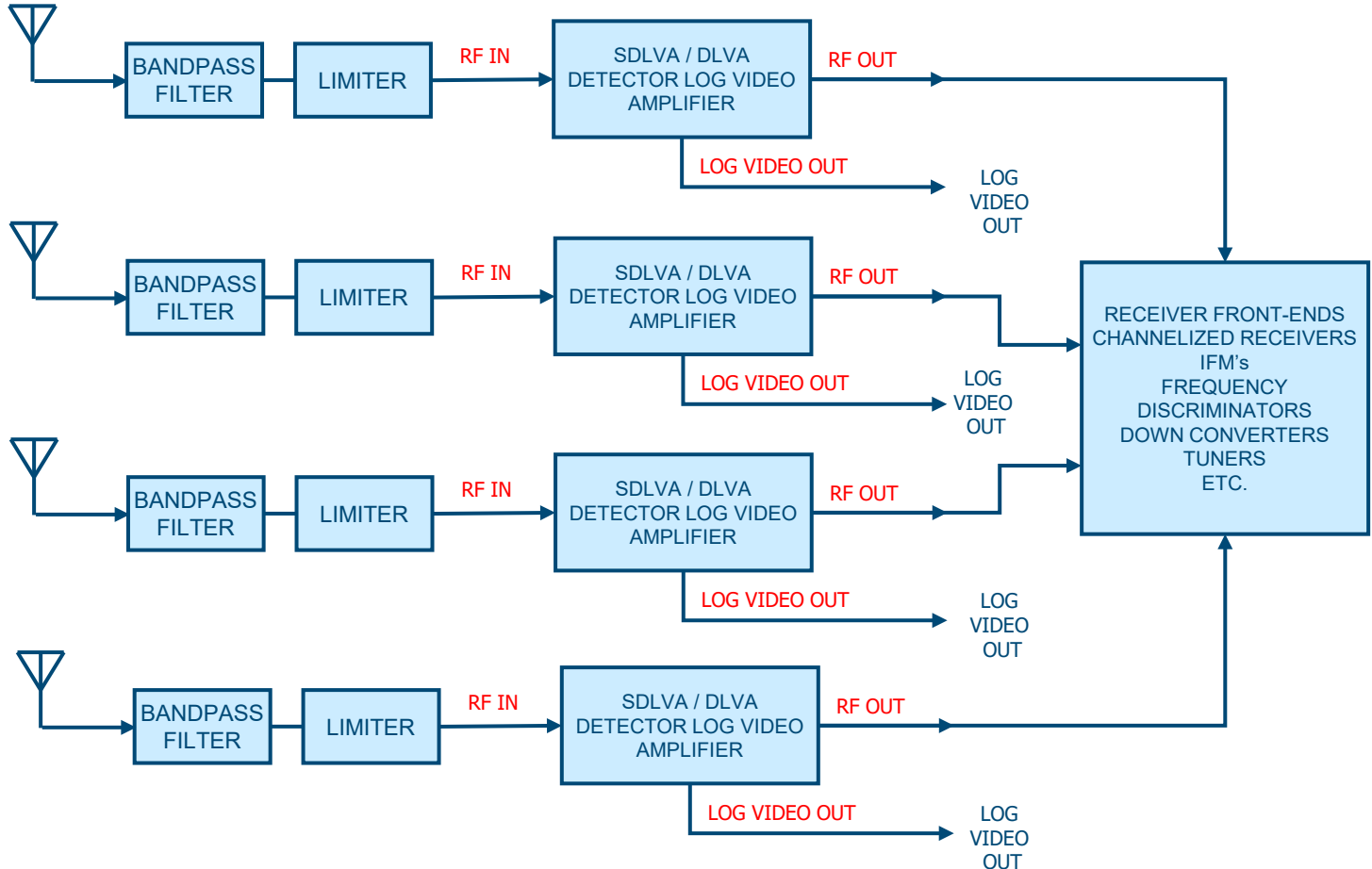

Quantic PMI can transform any MMIC or QFN into a DC – 70 GHz Hi-Rel Packaged Component

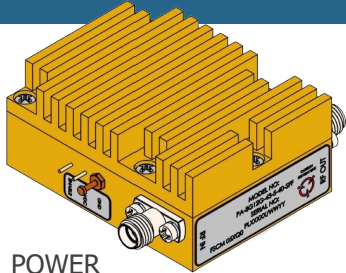

POWER

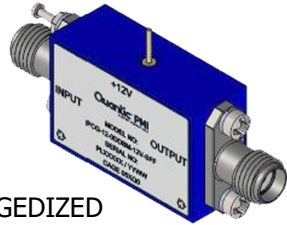

RUGGEDIZED

MINIATURIZED

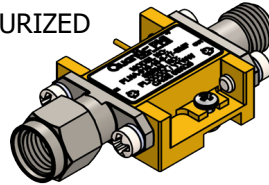

SURFACE MOUNT



CUSTOM
PACKAGING

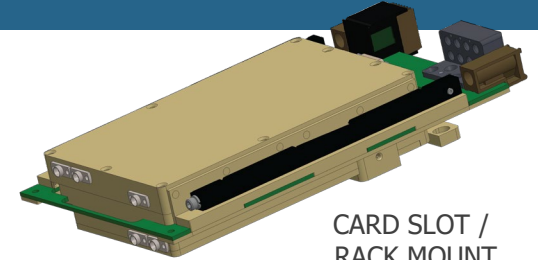
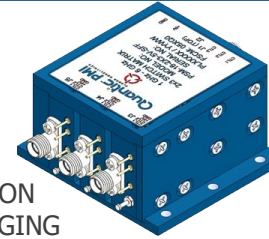

CARD SLOT /
RACK MOUNT

MIL-AERO – Hi-Rel Design & Packaging

- 20k sq/ft State of the art facility with 10k class cleanroom
- ISO9001/AS9100 certified
- ITAR Registered and Facility Clearance
- Kick off Meeting / CDR / PDR
- Complete Document Package
- Mean time between failure analysis (MTBF report)
- MIL-STD-810 Environmental Stress Screening (ESS)
- Qualification Testing (QTP / QTR)
- 100% MIL-STD-883 Inspection (Precap / ATP / SI)
- First Article Inspection IAW AS9102
- Recurring production – Continuous Acquisition & Life-cycle support (CALs)

Custom & COTS Solutions include

- Assembly including wire, ribbon, ball bonding 100% pull tested
- Hermetic, screw or epoxy sealing
- Form, Fit, Function Products & Services
- Over voltage and reverse protection
- Supply voltage conditioning (Regulation & noise filtering)
- Built in sequencing protection
- Control signals Digital or Analog
 - TTL, RS232, PECL, LVTTTL, BCD, Differential Pair, USB
 - Simple DC analog voltage
- Broadband DC Blocking networks
- EMI / ESD Shielding & Protection

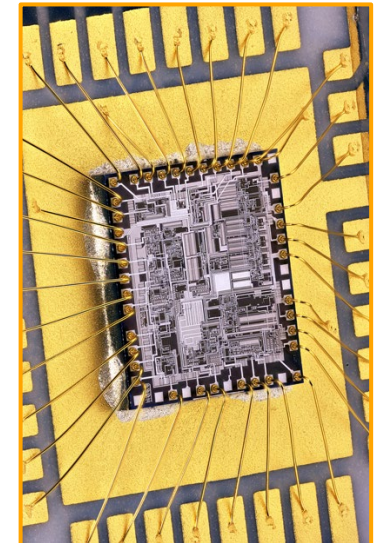

RF & Microwave Products

DC to 70 GHz

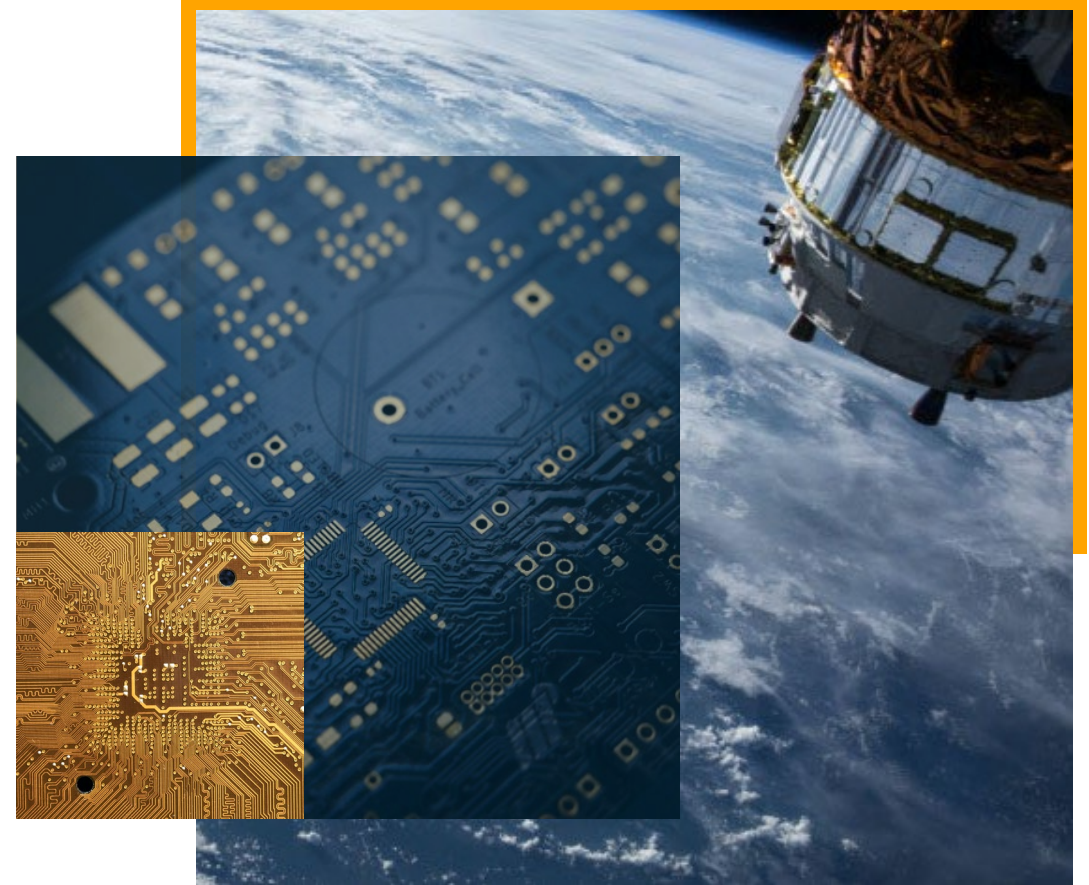

Products & Services

Solid State Amplifiers

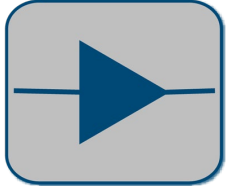

Attenuators - Variable / Programmable / Fixed



Detector Logarithmic Video Amplifiers

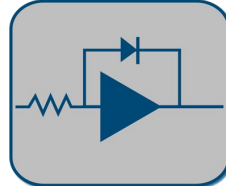

Filters & Switch Filter Banks



Frequency Converters

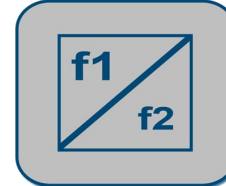

Frequency Discriminators & IFM

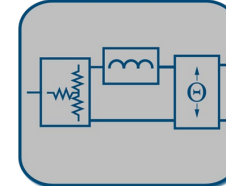

Frequency Sources

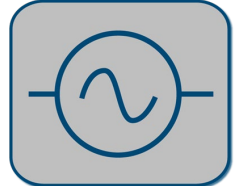

IQ Vector Modulators

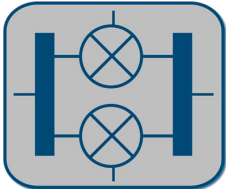

Limiters

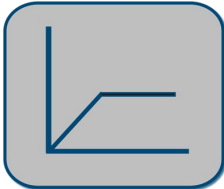

Phase Shifters & Bi-Phase Modulators



Solid-State Switches

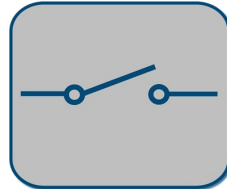

Detectors

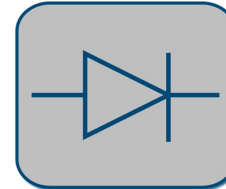

Form, Fit, Functional Products & Services

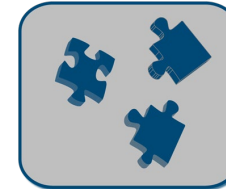

Gain & Loss Equalizers

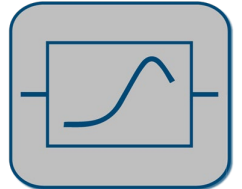

Integrated MIC / MMIC Assemblies (IMAs)

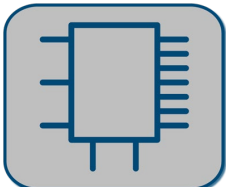

Miscellaneous Products

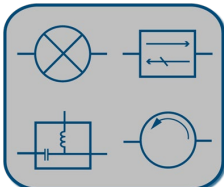

Monopulse Comparators

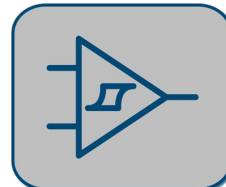

Power Dividers / Combiners

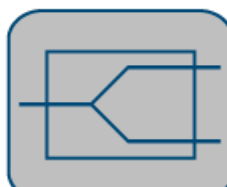

Rack & Chassis Mount Products

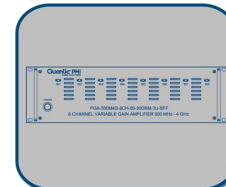

Receiver Front Ends & Transceivers

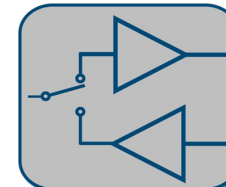

Switch Filter Banks

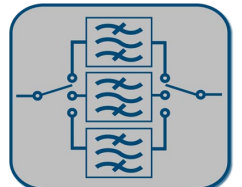

Switch Matrices

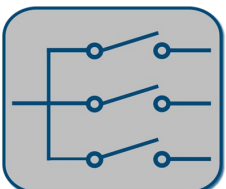

SMT & QFN Products

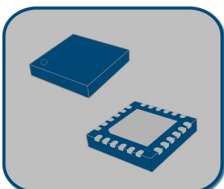

Couplers (90°, 180° & Directional)

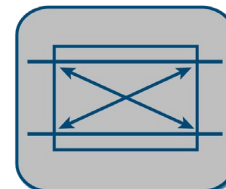

USB Products

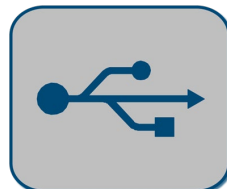

Detector Logarithmic Video Amplifiers

- > DLVAs, ERDLVAs, SDLVAs Designs
- > Exceptional Temperature Stability, Log Linearity & Frequency Response
- > TSS > -68 dBm & Fast Log Video Response Time
- > CW Immunity, Temperature Compensation & Matched Sets
- > Hermetic Sealing, Military or Aerospace Screening available
- > Connectorized or surface mount
- > Form, Fit & Function Products & Services
- > Custom Designs to Your Specifications



0.7 to 1.3 GHz
IF Logarithmic Amplifier
(SDLVA)

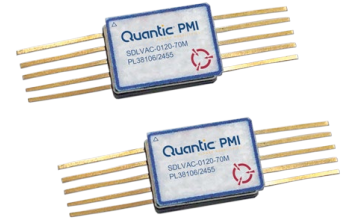

0.1 to 2 GHz
Miniature SDLVA



2 to 18 GHz,
65 dB CW Immune ERDLVA



Detector Log Video Amplifier



18 to 40 GHz DLVA



0.5 to 4 GHz SDLVA

Switches & Switch Matrices

- > Broadband Performance to 60 GHz
- > Solid State
- > Ultra-High Isolation
- > Low Insertion Loss
- > Ultra-High Speed
- > Low Power Consumption
- > SP1T - SP64T (Reflective or Absorptive)
- > Connectorized or Surface Mount
- > Hermetic Sealing, Military or Aerospace Screening available
- > Form, Fit & Function Products & Services
- > Custom Designs to Your Specifications



**0.1 to 20 GHz
SP4T Absorptive Switch**



**0.1 to 52 GHz
SP16T Absorptive Switch**

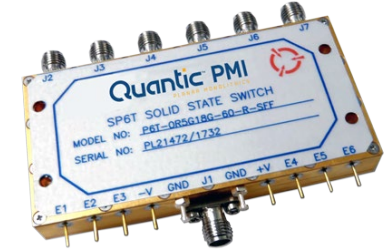

**0.5 to 18 GHz
SP6T Reflective Switch**



**7 to 18 GHz
SP20T Absorptive Switch**



**0.1 to 44 GHz
SP2T Absorptive Switch**



**0.1 to 56 GHz
SP2T Absorptive Switch**



**2 to 18 GHz
SP2T Absorptive Switch**



**100 MHz to 54 GHz
SP8T Absorptive Switch**



**20 MHz to 3 GHz, SP8T
Switch Matrix Assembly**

Solid State Amplifiers

- > Low Noise Amplifiers (Broadband, Narrow Band & Multioctave)
- > Variable Gain, High IP SIGINT & Limiting Amplifiers
- > Coaxial, Power, Test & Lab Use Amplifiers
- > Gain & Phase Matching
- > Hermetic Sealing, Military or Aerospace Screening available
- > Connectorized or surface mount
- > Form, Fit & Function Products & Services
- > Custom Designs to Your Specifications



2 to 18 GHz
High-Power Amplifier



Ultra-Low Noise Amplifier
Dual use component



0.25 to 20 GHz
Low Noise Amplifier



0.5 to 18 GHz
Dual Gain Amplifier



High Linearity,
Low Noise Amplifier



1 to 18 GHz
Portable Amplifier

Limiters

- > Broadband Performance to 62 GHz
- > High Peak Power Handling
- > Fast Recovery & Low RF Leakage
- > Low Insertion Loss
- > Small Size & Standardized Packaging
- > Hermetic Sealing, Military Screening available
- > Form, Fit & Function Products & Services
- > Custom Designs to Your Specifications



10 MHz to 6 GHz
2.5 W CW Limiter



10 MHz to 62 GHz
1.5 W CW Limiter



20 MHz to 18 GHz,
100 W CW RF Limiter



1 to 18 GHz, 3 W CW Limiter



32 to 36 GHz
20 W Peak Limiter



26.5 to 40 GHz
20 W Peak Limiter



18 to 40 GHz
2 W Limiter

Detectors - Diode, Directional, Threshold

- > Broadband Frequency coverage to 40 GHz
- > Low VSWR & Insertion Loss
- > Excellent Frequency Flatness
- > Small Package Size
- > Hermetic Sealing, Military or Aerospace Screening available
- > Form, Fit & Function Products & Services
- > Custom Designs to Your Specifications



10 MHz to 18 GHz
Low Noise Tunnel
Diode Detector



0.5 to 18 GHz, High Speed,
High Sensitivity Diode Detector



18 to 40 GHz, Low Noise,
Tunnel Diode Detector



4 to 26.5 GHz,
Zero Bias Schottky Detector



6 to 18 GHz
Biased Schottky Diode
Detector



2 to 18 GHz, High Speed,
High Sensitivity Diode Detector

Attenuators – Fixed, Digital or Analog Control

- Ultra-Broadband Performance to 50 GHz
- High Attenuation Accuracy
- Low Insertion Loss
- Excellent Frequency Flatness
- Analog or Digital Control Available
- High Speed & Very Small Packaging
- Hermetic Sealing, Military or Aerospace Screening available
- Connectorized or surface mount
- Form, Fit & Function Products & Services
- Custom Designs to Your Specifications



**13 to 14 GHz
8-Bit Programmable Attenuator**



**1 to 18 GHz
7-Bit Programmable Attenuator**



**0.1 to 0.3 GHz
Voltage Controlled Attenuator**



**1 to 4 GHz,
Voltage Variable Attenuator**



**3.1 to 3.5 GHz
Bi-Directional Variable
Attenuator**

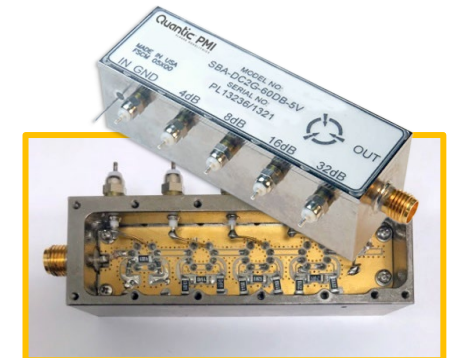

**DC to 2 GHz, Electro-mechanical
STEP Attenuator**

Phase Shifters

- > 0 to 360°
- > Broadband to 40 GHz
- > Ideal for Industrial & Military Applications
- > Analog or Digital Controlled
- > Fast Speed & Response
- > Low Insertion Loss
- > High Phase Accuracy
- > Hermetic Sealing, Military or Aerospace Screening available
- > Form, Fit & Function Products & Services
- > Custom Designs to Your Specifications



85 MHz to 4 GHz
Digitally Controlled Analog
Phase Shifter



0.2 to 10 GHz
8-Bit Digital Phase Shifter



2.0 to 18 GHz
12-Bit Vector Phase Shifter



32 to 37 GHz
8-Bit Digitally Controlled
Phase Shifter



6.0 to 18.0 GHz
10-Bit Digitally Controlled
Phase Shifter



2 to 18 GHz
8-Bit Phase Shifter



2 to 8 GHz, 8 Bit, 360°
Digital Phase Shifter

Bi-Phase Modulators

- 90°, 360° Models
- Low Insertion Loss
- Flat Response
- Digital Control
- High Phase Accuracy
- Hermetic Sealing, Military or Aerospace Screening available
- Form, Fit & Function Products & Services
- Custom Designs to Your Specifications



18 to 40 GHz
Bi-Phase Modulator



2 to 18 GHz
Bi-Phase Modulator



2 to 6 GHz
Bi-Phase Modulator/Shifter



1.1 to 1.12 GHz,
180° Bi-Phase
Modulator/Phase Shifter

I/Q Vector Modulators

- > Ultra-Broadband Performance to 40 GHz
- > High Speed Modulation
- > Analog & Digital I/Q Inputs
- > Low Spurious Response
- > Low Insertion Loss
- > High Absolute Phase Accuracy
- > Low Current Consumption
- > Hermetic Sealing, Military Screening available
- > Form, Fit & Function Products & Services
- > Custom Designs to Your Specifications



Vector Modulator



0.5 to 2 GHz,
I/Q Vector Modulator

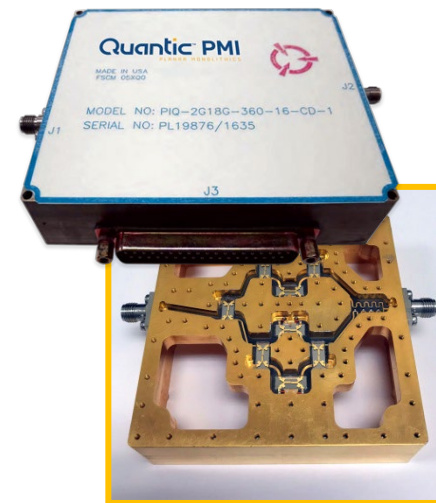

6 to 18 GHz,
I/Q Vector Modulator



85 MHz to 18 GHz, I/Q Vector Modulator

USB Products

- > Broadband Performance to 40 GHz
- > Low Noise Amplifiers, Variable Attenuators & Switch Designs available
- > Low Insertion Loss
- > All Models use Standard USB 2.0 port
- > SMA or 2.92mm Female Connectors
- > Hermetic Sealing, Military or Aerospace Screening available
- > Form, Fit & Function Products & Services
- > Custom Designs to Your Specifications



50 MHz to 18 GHz, 12 dB Gain
USB Powered LNA



50 MHz to 40 GHz, 12 dB Gain
USB Powered LNA



100 MHz to 18 GHz, 30 dB
USB Attenuator



100 MHz to 40 GHz, 30 dB
USB Attenuator



500 MHz to 18 GHz
USB Powered SP2T
Switch

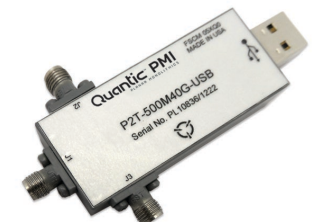

500 MHz to 40 GHz
USB Powered SP2T
Switch

Filters & Switch Filter Banks

- > Low-Pass, High-Pass, Band-Pass, Notch or Bandstop, Duplexers & Multiplexers
- > Filter Types: Lumped-Element, Cavity, Compline, Printed, Hairpin, Suspended Substrate, Edge-coupled, Stripline
- > Hermetic Sealing, Military or Aerospace Screening available
- > Connectorized or surface mount
- > Form, Fit & Function Products & Services
- > Custom Designs to Your Specifications



Band Pass Filter



1 to 20 GHz
6-Channel Switch Filter Bank



Low Pass Filter with
2400 MHz Cutoff
Frequency



DC to 26 GHz
5-Channel Switch Filter Bank

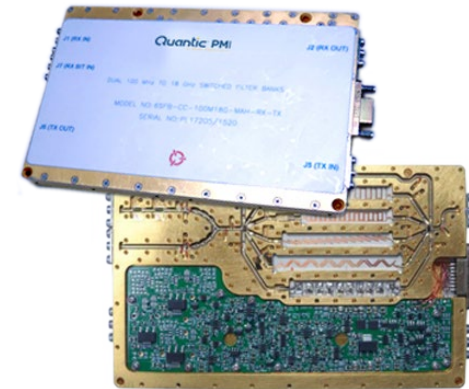

Double Sided, 100 MHz to 18.0 GHz
6 Channel Switch Filter Bank



Miniature, 2 Channel Switch Filter Bank

Couplers – 90°, 180°, Directional & Bi-directional

- > Broadband Response
- > High Isolation
- > Excellent Phase & Amplitude Balance
- > Small Package Size
- > Hermetic Sealing, Military or Aerospace Screening available
- > Form, Fit & Function Products & Services
- > Custom Designs to Your Specifications



DC to 18.0 GHz
Directional Coupler

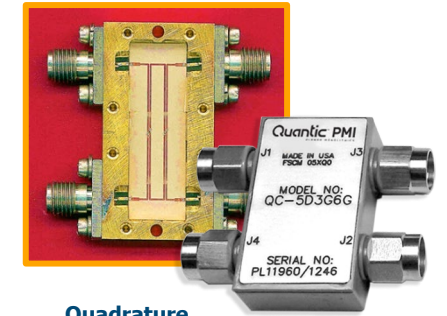

Quadrature
Couplers



5 to 10 GHz
Hybrid Coupler



8.0 to 11.0 GHz
Directional Coupler



0.02 to 6 GHz
90° Hybrid Coupler



90° Hybrid Coupler

Power Dividers/ Combiners (Passive & Active)

- Designs for Commercial, Military & Aerospace Applications
- Low Loss & High Isolation
- Excellent Amplitude & Phase Balance
- 2-Way to 16-Way Configurations
- Broadband Frequency coverage to 50 GHz
- Hermetic Sealing, Military or Aerospace Screening available
- Form, Fit & Function Products & Services
- Custom Designs to Your Specifications



18 to 40 GHz
2-Way Power Divider



2 to 20 GHz
8-Way Power Divider



20 MHz to 6 GHz, Amplified
4-Way Power Divider

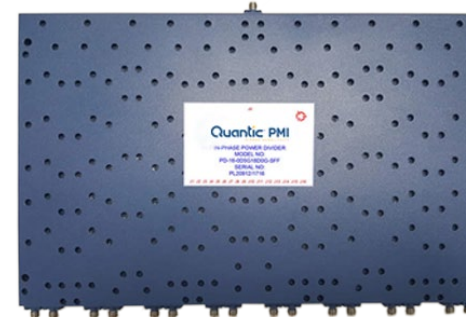

0.5 to 18 GHz
16-Way Power Divider



2 to 26 GHz
4-Way Power Divider



0.5 to 18 GHz
16-Way Power Divider



4.4 to 18 GHz, SMPM
4-Way Power Divider



100 MHz, Amplified
8-Way Power Divider

Monopulse Comparators

- > Frequency coverage up to 21.2 GHz
- > Rugged Coaxial Design
- > Low VSWR
- > High Power Handling with Minimum Insertion Loss
- > High Isolation between Channel Ports for Optimum Phase & Amplitude Balance
- > Hermetic Sealing, Military Screening or Aerospace Screening Available
- > Form, Fit & Function Products & Services
- > Custom Designs to Your Specifications



5 to 6 GHz
Monopulse Comparator



3 to 3.7 GHz
Monopulse Comparator



9.3 to 9.9 GHz
4-Way Phase Divider



12 to 13 GHz
Monopulse Comparator



20.2 to 21.2 GHz
Monopulse Circuit

Rack and Chassis Mount Products

- > Designs for Commercial, Military & Aerospace Applications
- > Supplied in Ruggedized, 1U to 6U chassis
- > A mixed set of functions:
 - Amplification
 - Attenuation (Digital Solid-State)
 - Switching (Ultra High Speed)
 - Power Detection / Fault Detection
 - Phase Shifting / Phase Modulation
 - Pulse Modulation / Noise Generation
 - RF Filtering / RF Limiting
 - Power Splitting
 - RF Signal Distribution
- > Form, Fit & Function Products & Services
- > Custom Designs to Your Specifications



Ethernet Microcontroller Test Box



Multiagent Radio Frequency Path Simulator



10 MHz to 6 GHz, High Gain Amplifier
Integrated Microwave Assembly



0.1 to 18 GHz High Gain Amplifier
Integrated Microwave Assembly



RF Signal Distribution Systems



0.5 to 18 GHz
16-Way Power Divider



10-Way Switch Filter Bank

Frequency Converters – BUC / BDC

- > Up / Down Converter Designs
- > Ideal for Industrial & Military Applications
 - Radar Warning, ECM, ESM & ELINT
 - EW / SIGINT
 - Radar Test Equipment
 - Microwave Radio
 - Instrumentation Modules
- > Designed to withstand stringent military ground or airborne environments
- > Frequency Coverage up to 40 GHz
- > Form, Fit & Function Products & Services

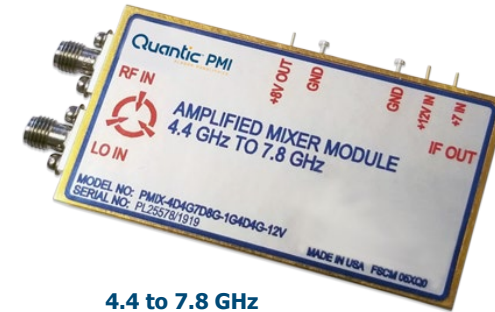

4.4 to 7.8 GHz
Down Converter Module



7.8 to 11.2 GHz
Down Converter Module



11.2 to 14.6 GHz
Down Converter Module



14.6 to 18 GHz
Down Converter Module

Frequency Sources

- > Designed for Industrial & Military Applications
 - Radar Warning, ECM, ESM & ELINT
 - EW / SIGINT
 - Radar Test Equipment
 - Microwave Radio
 - Instrumentation Modules
- > Synthesizers, DTOs, PLOs, PLDROs, , DROs, VCOs, OCXOs, Cos types available
- > All models can withstand stringent military ground or airborne environments
- > Frequency Coverage up to 40 GHz
- > High Level of Frequency Accuracy
- > Linearized Frequency Tuning
- > Low Frequency Drift, Phase Noise & Harmonic Content
- > Internal Digital Calibration
- > Temperature Compensation



**8.8 to 9.46 GHz
Temperature Stabilized Output
Medium Power X-Band Gunn-Effect
Oscillator**



**2.0 to 18.0 GHz,
Digitally Tuned Oscillator (DTO)**



**Digitally Tuned
Oscillators (DTOs)**



6 to 18 GHz, Synthesizer



Custom Frequency Doubler Module



**10 MHz Reference
Source**



**10.0 GHz, Integrated Phase
Shifter Dielectric Resonator
Oscillator (DRO) Module**



840 MHz Phase-Locked Oscillator

Frequency Discriminators & IFM

- > Designed for Industrial & Military Applications
 - Radar Warning (RW)
 - Electronic Countermeasures (ECM)
 - Electronic Support Measures (ESM)
 - Electronic Intelligence (ELINT) Applications
- > Digital or Analog Outputs
- > Narrow & Broadband Frequency Coverage up to 18 GHz
- > Hermetic Sealing, Military or Aerospace Screening available
- > Form, Fit & Function Products & Services
- > Custom Designs to Your Specifications



30 MHz, Frequency Discriminator



2.0 to 18.0 GHz Digital Frequency Discriminator



1 GHz, Frequency Discriminator



3.1 to 3.5 GHz Frequency Discriminator



1 to 18 GHz, Frequency Discriminator

Delay Line in a Frequency Discriminator

Gain & Loss Equalizers

- Ideal for Equalizing Cable Loss or Gain Flatness
- Narrow-bandwidths or broadband up to 40 GHz
- Low Insertion Loss & VSWR
- Various frequency equalization values
- Multiple and Custom slope characteristics
- Surface Mount or Connectorized
- Hermetic Sealing, Military or Aerospace Screening Available
- Form, Fit & Function Products & Services
- Custom Designs to Your Specifications



26.5 to 40 GHz, 1.5 dB
Passive Amplitude Equalizer



17.6 to 21.6 GHz, 12 dB
Passive Amplitude Equalizer

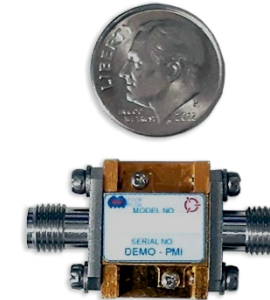

DC to 40 GHz
Passive Equalizer

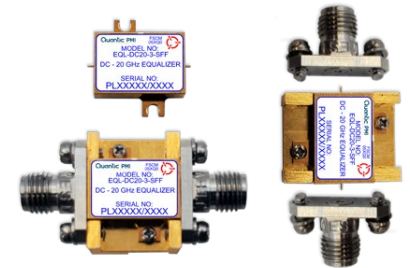

DC to 20 GHz
Passive Equalizer

SMT & QFN Products

- > Quantic PMI offers Surface mount (SMT) & QFN packaging for many types of devices....SDLVA's, Log Amplifiers, Phase Shifters, Attenuators, Switches, as well as Low Noise Amplifiers.
- > Multifunction options available in a single QFN package such as Limiters / LNA or LNA / Detectors.
- > Custom devices that meet your specific control function can be designed & integrated into specified packaging with the required testing.

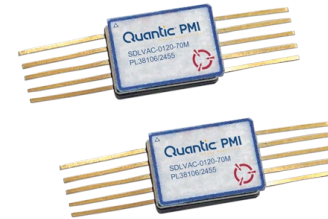

0.1 to 2 GHz
Miniature SDLVA

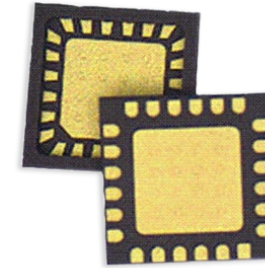

14.4 to 15.4 GHz
RF Limiter & Low Noise Amplifier

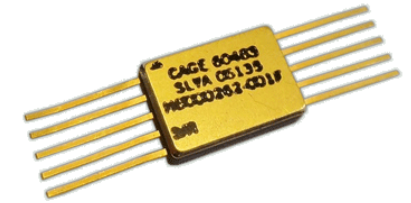

0.6 to 1.35 GHz
Miniature SDLVA



10 MHz to 62 GHz
High Power Limiter

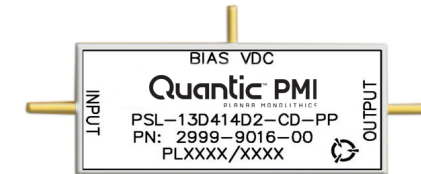

13.4 to 14.2 GHz
High Power Switch Limiter



DC to 20 GHz
Equalizer



18.0 to 40 GHz
High Power Limiter



0.7 to 1.3 GHz
Miniature SDLVA



14.4 to 15.4 GHz
High Power SPST Switch

Receiver Front End & Transceiver Products

- > Designs for Commercial, Military & Aerospace Applications
- > Broadband Frequency coverage to 50 GHz
- > Hermetic Sealing, Military or Aerospace Screening available
- > Form, Fit & Function Products & Services
- > Custom Designs to Your Specifications



2 to 18 GHz
Direction Finding Receiver Front End



100 MHz to 18 GHz
Transceiver (Phase II)

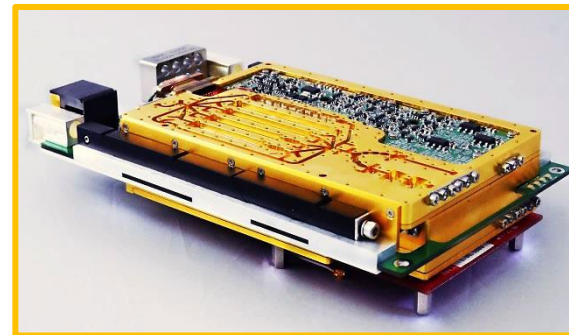

100 MHz to 18 GHz Transceiver (Phase III)



100 MHz to 18 GHz Transceiver Unit

100 MHz to 18 GHz Transceiver

- Integrated Up and Down Converters
- IF up to 4 GHz
- Time Gated SDLVA for Pulse Blanking
- -80 to -10 dBm Input Dynamic Range
- Customizable Switch Filter Banks
- 0 to +10 dBm Transmit Power
- 100 ns Switching Speed
- Fits into a 3U open VPX form factor utilizing the high-speed VITA 67 RF connector
- CW Immunity

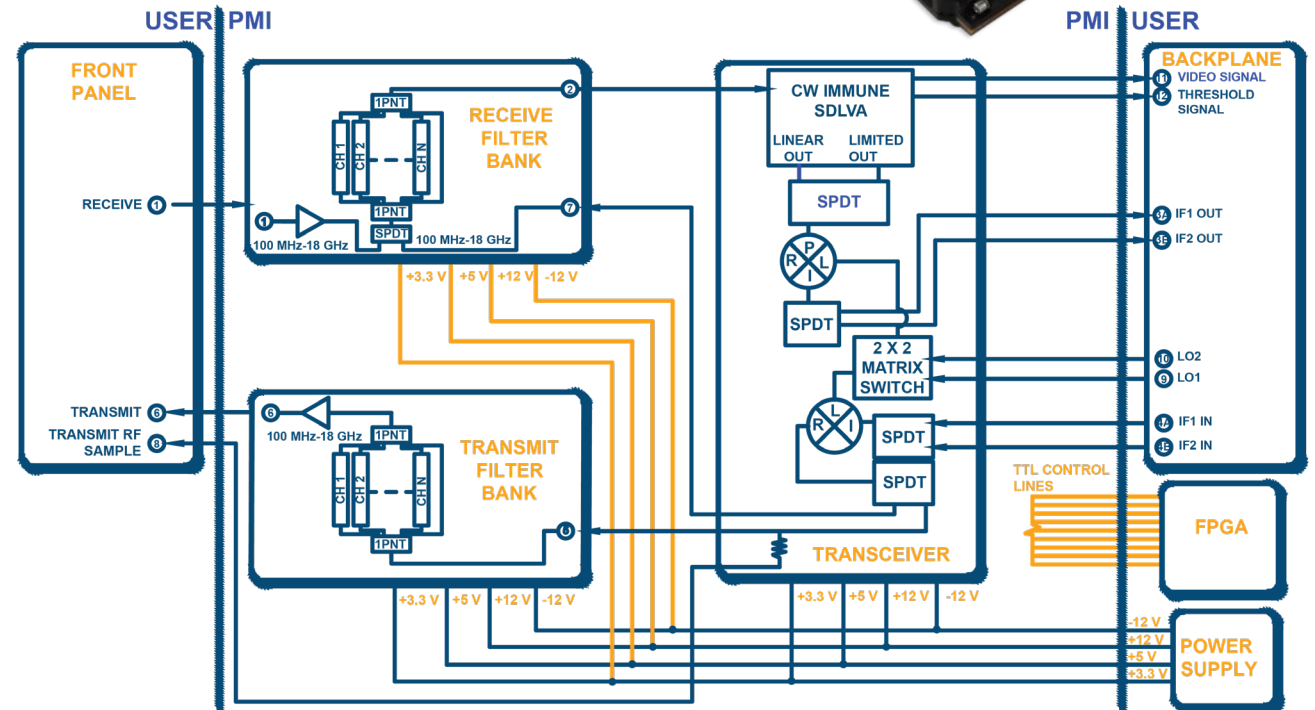

Integrated MIC/MMIC Modules & Assemblies (IMAs)

- > Broadband to 50 GHz
- > Built to your specifications with functions:
 - Amplification
 - Attenuation
 - Filtering
 - Frequency Discrimination
 - Switching
 - Phase Shifting
 - Power Detection
 - Modulation/Demodulation
 - Coupling
 - Limiting
 - Digital/Analog Control
- > Hermetic Sealing, Military Screening available
- > Form, Fit & Function Products & Services
- > Build to Print or Built to your SCD



0.5 to 18.0 GHz, Custom Phase ($\pm 10^\circ$) & Amplitude (± 1.5 dB) Matched Integrated Modules/ Assemblies



2.6 to 5.2 GHz 8 Channel Selectable LO Frequency Source



10.0 GHz, Integrated Phase Shifter and Dielectric Resonator Oscillator (DRO) Module (Inside)



7.7 to 8.2 GHz Laser Control Module

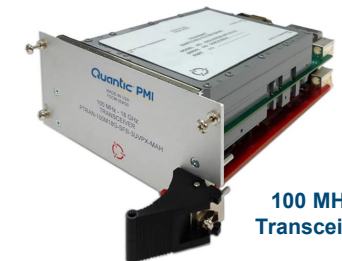

100 MHz to 18 GHz Transceiver (Phase II)

Integrated MIC/MMIC Modules & Assemblies (IMAs)



2021 **Military & Aerospace Electronics** Innovators Awards
PLATINUM HONOREE



1 to 18 GHz Channelized Receiver

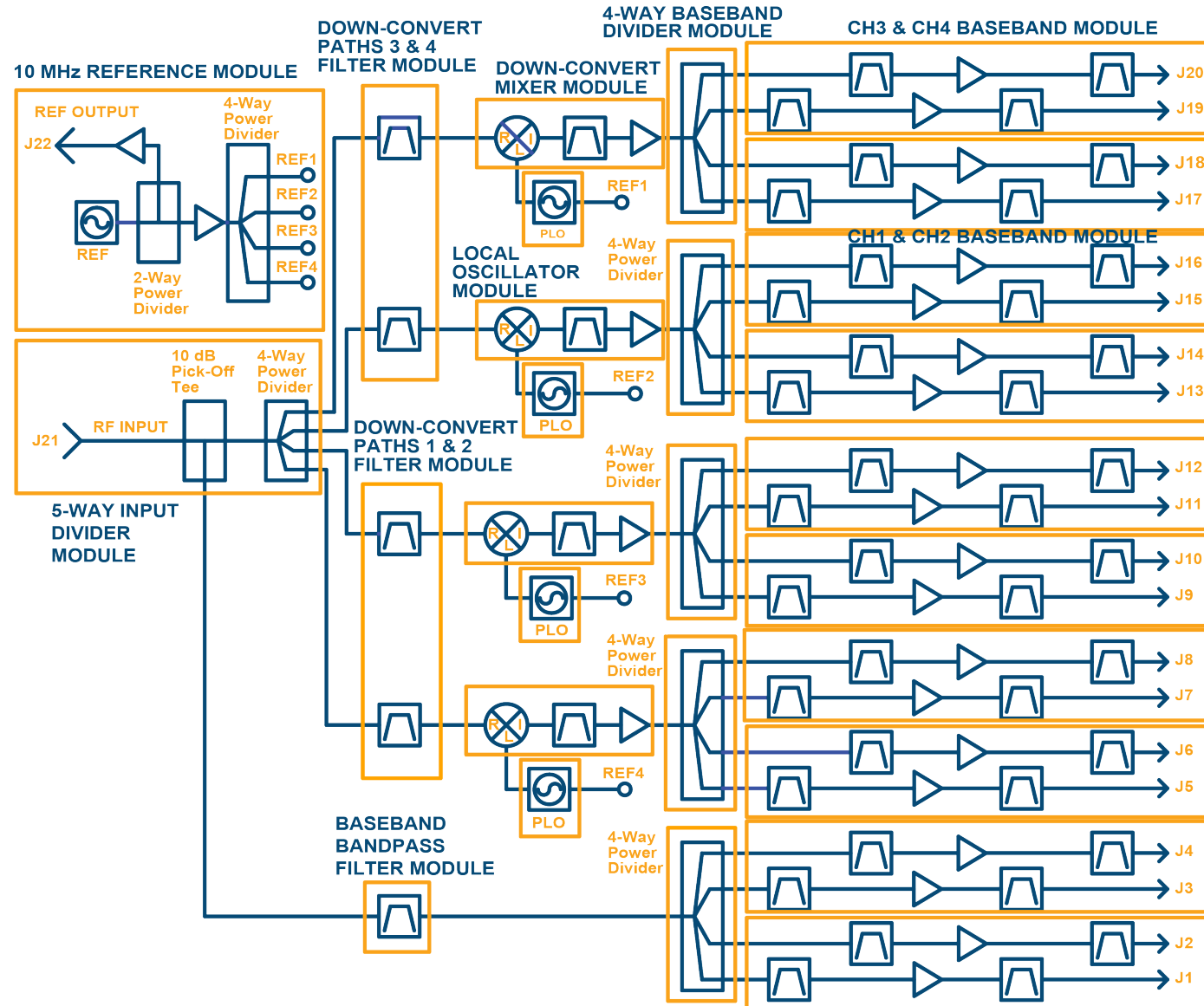

Miscellaneous Products

- > Bias Tees & Pick-Off Tee
- > Isolators/Circulators
- > Mixers & Prescalers
- > Through Package Housings
- > Small Size & Standardized Packaging
- > Hermetic Sealing, Military Screening available
- > Form, Fit & Function Products & Services
- > Custom Designs to Your Specifications



2 to 18 GHz
Active Mixer

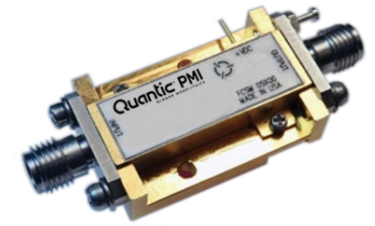

1 to 2 GHz Bias Tee



4 to 12 GHz
Double Balanced Mixer



0.5 to 18 GHz
Divide-by-4 Prescaler



6 to 20 GHz
Double Balanced Mixer



8 to 12 GHz
Image Reject Mixer

In-Stock / COTS Products – Same Day Shipping



> Select Quantic PMI products are available from stock that can be shipped from Quantic PMI directly or one of its authorized distributors to you the same day.

<https://www.quanticipmi.com/stock-items>

A screenshot of the Quantic PMI website. The top navigation bar includes 'Home', 'About Us', 'Product Categories', 'Literature', 'Stock Items', 'Events', and 'Contact Us'. The main content area displays the product page for 'LM-150M5G-200CW-2KWPK-AGAL', an 'Ultra-High Power Limiter'. A 'Buy Now' button is highlighted with a white box. Below this, a table lists various products under the category 'Limiters - RF / Microwave / mmWave'. Two products, 'LM-218-14-200W-SMF' and 'LM-6G18G-15-10W-SFF', are highlighted with white boxes and 'Buy Now' buttons. The footer contains 'Career', 'Sign Up', 'Product Categories', 'Literature', and 'Privacy Terms & Services'.

Our Partners



Facilities

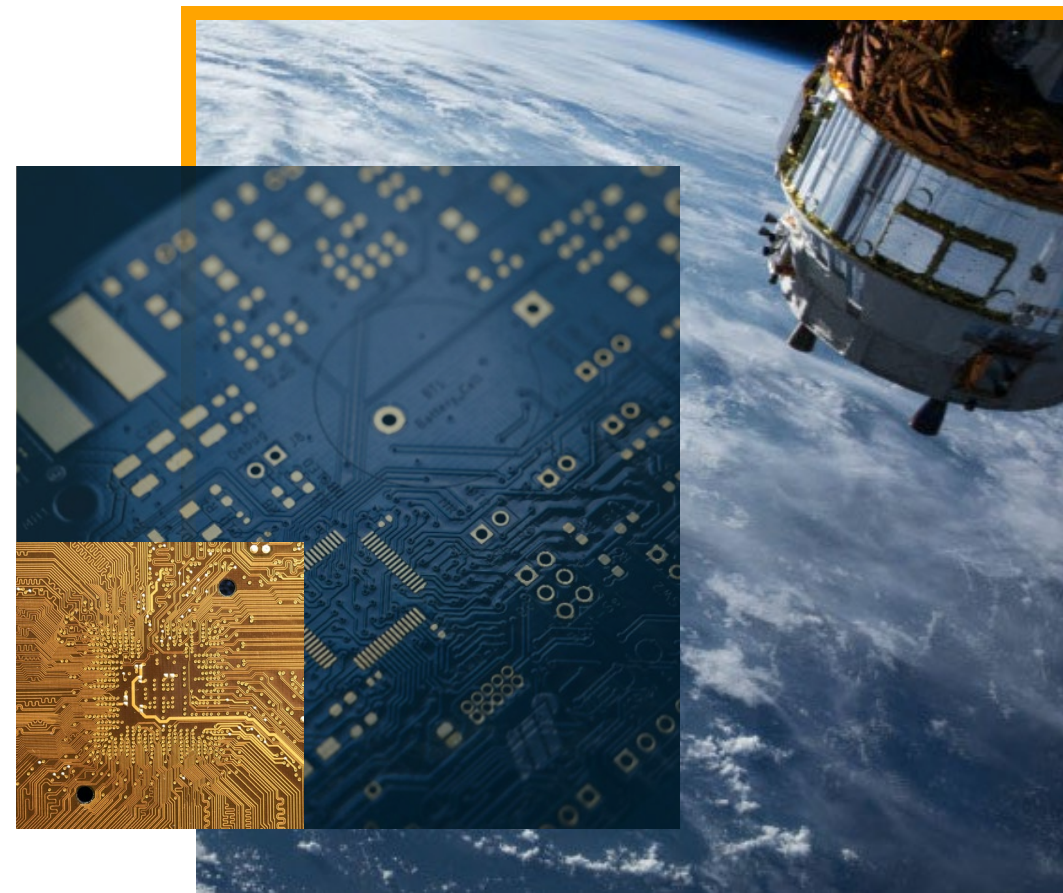

7309-A GROVE ROAD, FREDERICK, MD:

- > 20,000 sq. ft. Facility
- > 7,500 sq. ft. Class 10,000 ppm Clean Room for Assembly, Test, ESS & Inventory
- > 4,000 sq. ft. Engineering Space
- > 2,800 sq. ft. Office space and Conference rooms
- > 2,500 sq. ft. Machine Shop, Paint Booth, and Random Vibration/Shock Testing
- > 2,200 sq. ft. Communal areas (2 breakrooms, restrooms, and lobby)
- > 1,000 sq. ft. Accounting, Human Resources and Sales & Marketing
- > Components & Sub-Assembly Manufacturing
- > Hybrid Assembly
- > Engineering & Test Departments
- > QA/QC, Sales, Marketing & Executive Offices
- > 3 Conference Rooms (Production, Engineering and S&M)

4921 Robert J. Mathews Pkwy, El Dorado Hills, CA:

- > 5,100 sq. ft. Facility
- > Components Manufacturing
- > Hybrid Assembly
- > Test and Engineering Departments
- > Production and Quality Departments
- > EOL and Obsolete Aftermarket Manufacturing

East Coast Operations



East Coast Operations

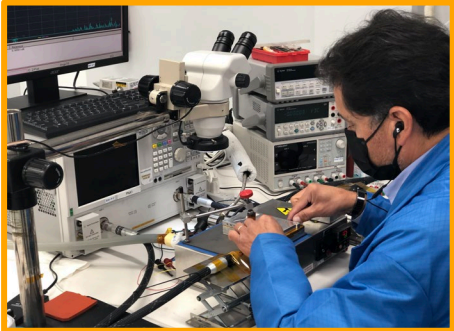



Footer

East Coast Operations

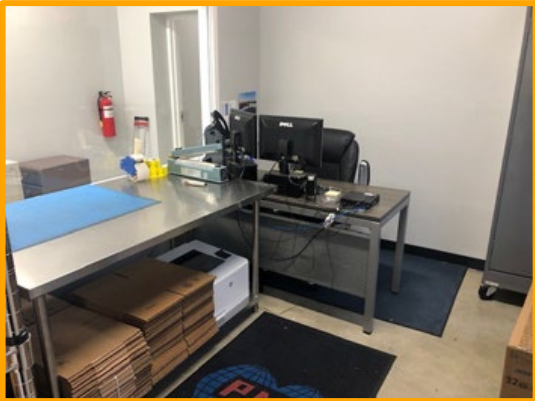

East Coast Operations



Hermetic Laser Welder



Shock Testing



Thermal Shock



Thermal Shock

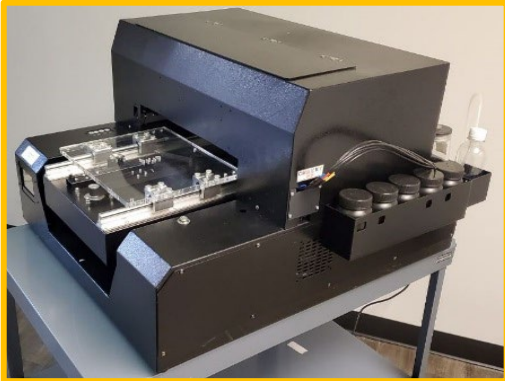

UV Curing Light Printer



CO₂ Laser



Hot/Cold Plate



Random Vibration

East Coast Operations



Cycling Chamber



Plasma Cleaners



Metallurgic Microscope



HAAS DT1 CNC Milling Machine



Hermetic Package Testing

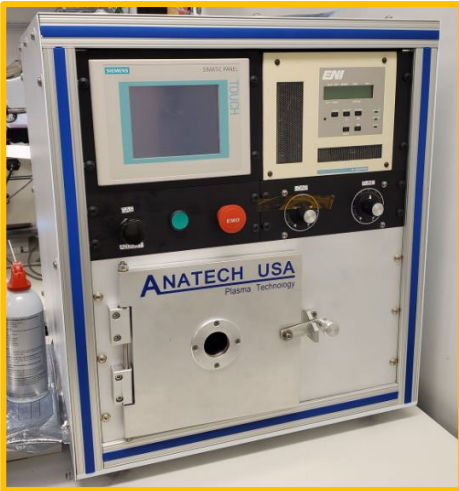

East Coast Operations



Mazak Nexus 430A-II CNC Milling Machine

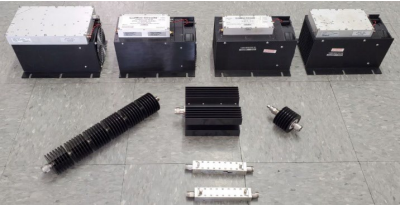
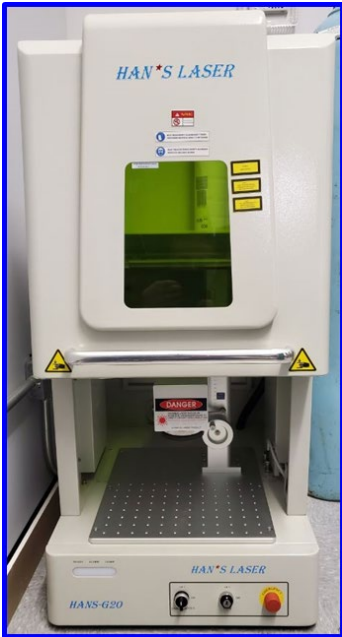
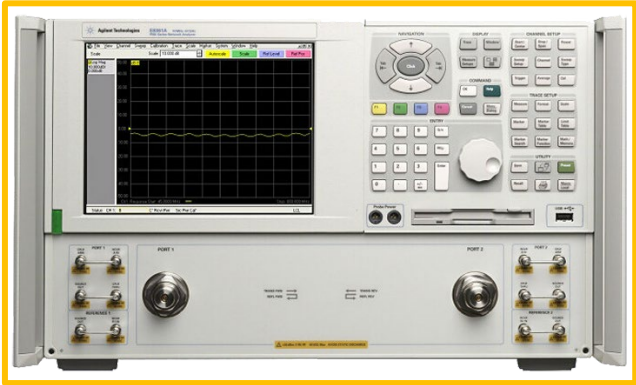

Network Analyzers:

- > (1) Keysight E8361C PNA (10 MHz to 67 GHz)
- > (1) Keysight N4694A E-CAL Module (10 MHz to 67 GHz)
- > (3) Agilent N5230A PNA (10 MHz to 40 GHz)
- > (2) Agilent N5230A PNA (10 MHz to 20 GHz)
- > (1) Keysight 50 GHz PNA
- > (2) Agilent N5230C-420 PNA-L (10 MHz to 40 GHz)
- > (2) Agilent N4691 E-CAL (10 MHz to 20 GHz)
- > (2) Agilent N4692 E-CAL (10 MHz to 40 GHz)
- > (1) Agilent E8363C PNA (10 MHz to 40 GHz)
- > (1) Keysight E8364B PNA Network Analyzer (10 MHz to 40 GHz)
- > (1) Keysight N5234A PNA-L Network Analyzer (10 MHz to 43.5 GHz)
- > (3) Keysight N5234A PNA-L Network Analyzer (10 MHz to 50 GHz)
- > (1) Keysight N4692A E-CAL (10 MHz to 50 GHz)
- > (1) Keysight 8362B Network Analyzer (10 MHz to 20 GHz)

Noise Figure Meter:

- > (2) Agilent N8975A (10 MHz to 26.5 GHz) & Downconverter (40 GHz)
- > (1) HP 8970B

Oscilloscopes:

- > (1) Tektronix TDS210
- > (1) Tektronix TDS2024C
- > (1) Agilent DS06034A
- > (1) Keysight DSO80204B
- > (1) Keysight DSOS204A
- > (4) Agilent DSOX3034A
- > (1) Keysight (2 GHz BW)

Power Amplifiers:

- > (1) Varian TWTA 7 – 18 GHz, 20 W
- > (1) 2.0 to 18.0 GHz 200 W CW TWT Amplifiers
- > (1) CPI TWT Amplifier (2-8 & 8-18 GHz) 300 W CW
- > (1) SSPA 10 MHz to 2.0 GHz, 100 W CW
- > (1) MC (3-3.5 GHz) 100 W
- > (1) MC (800 – 1000 MHz) 100 W
- > (1) MC (20 -512 MHz) 25-50 W
- > (1) MC (20-500 MHz) 100 W
- > (1) Spanawave GT-1051B Power Amplifier, 10 MHz to 50 GHz, 0.5 W to 40 GHz, 0.4 V to 50 GHz

Power Meter:

- > (3) Gigatronics 8541B/C, 8542C
- > (4) Agilent E4418B
- > (1) Agilent N1913A

Pulse/Signal Generators:

- > (1) Agilent E8257D
- > (1) Anritsu MG3692B
- > (1) HP 8015A
- > (1) HP 8013B
- > (1) HP 8012B
- > (1) HP 8350B Sweep Oscillator
- > (1) HP Arbitrary Waveform Generator 33120A
- > (1) HP 8664A
- > (1) Wavetek Model 801
- > (2) HP 8673D
- > (2) Agilent 33522A Arbitrary Waveform Generator
- > (2) Keysight E8257A PSG Analog Signal Generator
- > (5) Keysight E8257D PSG Analog Signal Generator
- > (1) Siglent SDG1062X and Siglent SDG1032X Waveform Generators

Spectrum Analyzer:

- > (1) HP 8593E
- > (1) HP E4448A PSA Spectrum Analyzer (3 Hz to 50 GHz)
- > (1) Keysight N9030A Spectrum Analyzer (3 Hz to 50 GHz)
- > (1) Keysight 8563E Spectrum Analyzer (9 kHz - 26.5 GHz)

Manufacturing Equipment:

- > (2) ESPEC TSE-12A Thermal Shock Chamber
- > (1) TSE-11-A ESPEC Thermal Shock Chamber
- > (1) ESPEC BTZ-175 Cycle Chamber
- > (1) LAB SD10 Shock Tower
- > (1) JEN410 IR Reflow Oven
- > (1) Thermo Electron Oven
- > (2) Anatech Plasma Cleaner
- > (1) Metallurgical Microscope MT1000
- > (5) Westbond 747677E-79 Convertible Wire Bonder
- > (1) Westbond 7476E-79 Wedge Wire Bonder
- > (1) Westbond 747630E-79 Wedge Wire Bonder
- > (1) Westbond 7400A Wedge Wire Bonder
- > (2) Westbond Bond Pull Center
- > (1) Dage Bond Puller / Die Shear
- > (1) Unitek Unibond-II Parallel Gap Welder
- > (3) HAAS DT1 CNC Milling Machine
- > (1) Mazak Nexus 430A-II CNC Milling Machine
- > (1) Hardinge Turret Lathe
- > (1) Di-Acro Power Shear

- > (10) ESS Thermal Hot/Cold Plates
- > (1) Ling Dynamic V650 Random Vibration Setup
- > (1) Shock Tester
- > (1) Varian Helium Leak Tester
- > (1) 20 W Fiber Laser
- > (1) Hermetic Package Tester
- > (1) UV Curing Light Printer
- > (1) Hermetic Laser Welder
- > (1) CO2 Laser

Software:

- > Keysight - Genesys S/Filter Synthesis and Simulation
- > Ansys – HFSS, High Frequency Structural Simulator
- > Exact MAX – MRP/ERP Software
- > AutoCAD
- > Altium Designer
- > Microwave Office
- > SolidWorks
- > Gibbs Cam

Standards:

- > ISO9001
- > MIL-STD-454
- > MIL-STD-202
- > MIL-STD-883
- > MIL-E-5400
- > MIL-I-45208
- > IPC-A-610 Workmanship Standard
- > IPC-J-STD-001 Soldering Standard
- > MIL-STD-45662 Calibration Standard

West Coast Operations

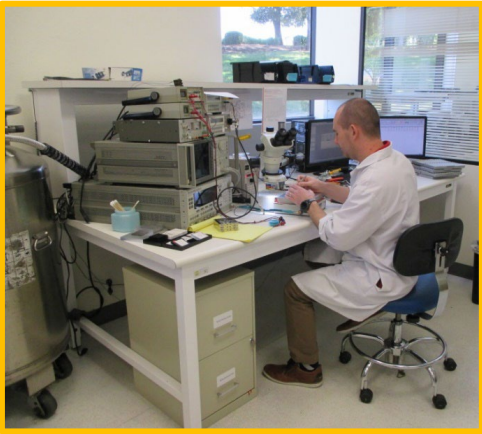

West Coast Operations



Network & Spectrum Analyzers:

- > (1) Agilent N5230C PNA Network Analyzer 10 MHz-20 GHz (Mixer Option)
- > (5) HP 8757D Scalar Analyzers
- > (1) HP 8720D Network Analyzer
- > (1) HP 8565E Spectrum Analyzer (50 GHz)
- > (1) HP 8592L Spectrum Analyzer
- > (1) Keysight E8364B PNA Network Analyzer (10 MHz to 50 GHz)

Noise Figure Meters:

- > (1) HP 8970A Noise Meter
- > (1) Keysight N4002A Noise Source

Power Meters:

- > (1) HP EPM-442 Power Meter
- > (1) HP E4412A Power Meter
- > (1) HP 437B Power Meter
- > (1) HP 437A Power Meter

Pulse/Signal Generators:

- > (1) HP 83731B Signal Generator
- > (1) HP 83620A Signal Generator
- > (1) HP 8013B Pulse Generator
- > (4) HP 83620A Sweep Generators

Oscilloscopes:

- > (1) Infiniium Digital Scope & Probe
- > (1) Keysight MSO-X-3054A 500 MHz BW
- > (1) Tektronix 2246 100 MHz BW
- > (1) Tektronix 2465A 350 MHz BW

Manufacturing Equipment:

- > (1) Quincy Model 40 Oven
- > (1) Sym-Tek P162P5J Oven
- > (1) Cole/Parm 05015-50 Oven
- > (1) Blue M Stable Therm Oven
- > (1) Branson 821D Ultrasonic Cleaner
- > (2) UNITEK Gap Welders
- > (1) Anatech Plasma Cleaner/Etcher
- > (3) Westbond 7400A Wedge Bonders
- > (1) Westbond 8850 Bond Pull Center
- > (3) Westbond 1200A Die Attach Stations
- > (2) Westbond 8849 Convertible Wire Bonder
- > (1) Westbond 8850 Ball Bonder
- > (1) Westbond 7600B Ribbon Bonder
- > (4) Thermal Hot/Cold Plates
- > (4) Hot Plates

Software:

- > Keysight - Genesys S/Filter Synthesis and Simulation
- > Ansys – HFSS, High Frequency Structural Simulator
- > Exact MAX – MRP/ERP Software
- > AutoCAD 2005
- > AutoCAD 2013
- > Gibbs Cam

Standards:

- > ISO9001
- > MIL-STD-454
- > MIL-STD-202
- > MIL-STD-883
- > MIL-E-5400
- > MIL-I-45208
- > IPC-A-610 Workmanship Standard
- > IPC-J-STD-001 Soldering Standard
- > MIL-STD-45662 Calibration Standard

- > Equipment Calibration - ISO 17025 Standard with traceability to NIST
- > Trained and Experienced ITAR/Export Administrator
- > Export Compliance Manual
- > AES (Automated Export System) certified export staff
- > Long Term Relationships with both DDTC and SNAP-R Personnel
- > NIST SP 800-171 and DFARS 252.204-7012 Compliant
- > U.S. Government Registration Numbers:
 - Cage Code: 05XQ0 (East Coast)
 - Cage Code: 71A34 (West Coast)
 - DUNS Number: 829998517
 - SAM (CCR) Registration: 1998E211401
 - Federal Tax ID (TIN): 52-1756966
 - DDTC Registrant Code: M16913
- > Able to support DoD contracts



QMS Assessment, Training Solutions & Product Inspection Services since 1995

5216 Chairmans Ct., Suite 103
Frederick, Maryland 21703
(301) 696-9740 Office
(301) 829-3729 Fax
www.IQRCORP.COM

International Quality Registrars (IQR) Corporation
herewith certifies that

Planar Monolithics Industries, Inc.

Headquarters: 7311-F Grove Road, Frederick, MD 21704 USA
Site 2: Machine Shop: 5715 Unit 11 Industry Lane, Frederick, MD 21704 USA
Site 3: Design & Mfg. 4921 Robert J. Mathews Parkway, Suite # 1, El Dorado Hills, CA 95762 USA

Additional Site Location(s): No, Yes, See Appendix A for additional information

has demonstrated a Quality Management System (QMS) which
conforms with the requirements of the standard:

ISO 9001:2015
Quality Management System - Requirements

The organization's QMS has been evaluated
according to the International Quality Registrars (IQR)
Corporation QMS certification scheme for the following scope:

**"Design, Development and Manufacture of Microwave Frequency Components, Sub-Systems and
Systems, and Contract Manufacturing Services"**

Exclusion(s): None

This QMS certification is subject to periodic audits by
International Quality Registrars (IQR) Corporation

This QMS certificate remains the property of International Quality Registrars Corporation and shall be returned immediately upon request, and is subject to being suspended or withdrawn where the organization fails to comply with the terms and conditions of the signed Registration Assessment Proposal and Agreement. An electronic or printed certificate can be authenticated on-line in accordance with IQR's procedure documented at www.IQRCORP.com

Registration No.: 18-120804.1Q
Client ID: PM109
Cert. Expiration Date: 09/15/24
Cert. Issued Date: 09/15/21

Last Cert. Revision Date: 09/15/21
Initial Cert. Issue Date: 02/24/09
Sheet No.: 1 of 2

IQR QMS Certification Signature



FORM IQR-2510 Rev. A

FORM IQR-2503 Rev. C



United States Department of State
Bureau of Political-Military Affairs
Directorate of Defense Trade Controls
Washington, D.C. 20522-0112

SEBASTIAN PALACIO
Vice-President
Planar Monolithics Industries Inc.
7311-F Grove Road
Frederick, MD 21704

2022-08-04

REGISTRANT CODE: M16913
EXPIRATION DATE: 2023-08-31

Reference: Manufacturer/Exporter Registration Statement and Fee Submission

Dear SEBASTIAN PALACIO:

The Office of Defense Trade Controls Compliance received your registration statement and fee to register as a manufacturer and exporter. We have reviewed your registration statement and your registration code is M16913, which expires on 2023-08-31.

Any person who engages in the United States in the business of either manufacturing or exporting defense articles or furnishing defense services is required to register and keep that registration current with this office pursuant to the Arms Export Control Act (AECA) and the International Traffic in Arms Regulations (ITAR Part 122). Registration serves as a precondition to submitting an application for an export license or other approval from the Directorate of Defense Trade Controls (DDTC), or to use export exemptions. This registration does not satisfy the requirements for registering as a broker pursuant to ITAR Part 129.

As you are the senior officer empowered to sign the registration statement, we ask you to maintain records consistent with ITAR Section 122.5 regarding: 1) The key senior officer listed on the registration who will oversee the compliance program and be responsible for designating the direct employees who will serve as "empowered officials" at their place of employment, and 2) A list of qualified, direct employees who will serve as "empowered officials" by name, position, business unit, phone and fax numbers and email addresses. Please note that third parties (individuals who are not direct employees, such as consultants, subcontractors or outside counsel, for example) cannot serve as "empowered officials."

ITAR Section 122.5 requires you to maintain records concerning your registration and the manufacture, acquisition and disposition of defense articles; the provision of defense services; and information on political contributions, fees, or commissions furnished or obtained, as required by ITAR Part 130. Records maintained shall be available at all times for inspection and copying by this office or by Customs officials. To maintain such records, managers, supervisors and employees need appropriate training on AECA and ITAR requirements and must understand the individual and organizational ramifications of failure to comply. Ramifications may include shipment delay and/or shipment seizure by Customs and Border Protection, loss of export privileges, or criminal charges.

You may refer to the DDTC website for a Compliance Guide at <http://www.pmdtc.state.gov/> and then click on the ITAR Compliance tab, next click on How to Comply tab. The DDTC website also includes a copy of the ITAR, explanations of export licensing procedures, how to submit a license

application, country sanctions, individuals / companies debarred by the Department of State, and other export matters. The website also includes procedures for requesting a commodity jurisdiction determination (ITAR Section 120.4) should you have questions on whether an article, services, or technical data is covered by the ITAR Part 121 (U.S. Munitions List).

Please include your registration code and the following statement on all registration correspondence to this office: "Under penalty according to federal law (22 CFR 127.2, 22 USC 2778, 18 USC 1001) I, [insert your name], as authorized by [name of company, if applicable] warrant the truth of the statements made herein." We recommend submitting for registration renewal well in advance to ensure this office receives the request up to 60 days before registration expiration date. However, your registration must be received at least 30 days prior to this new expiration date. Registration must be current to apply for export licenses or other approvals, or to use export exemptions. Your registration is not current, for example, if you have not notified this office of any material change in the information contained in your Registration Statement (ITAR Section 122.4).

For general registration related questions, please contact the DDTC Response Team at 202-663-1282 or by email at ddtcustomerservice@state.gov. For questions related to this matter, please contact Telethia Thomas at 202-632-2153.

Sincerely,

Daniel Cook
Chief, Registration, Compliance, & Analysis

Organizational Chart

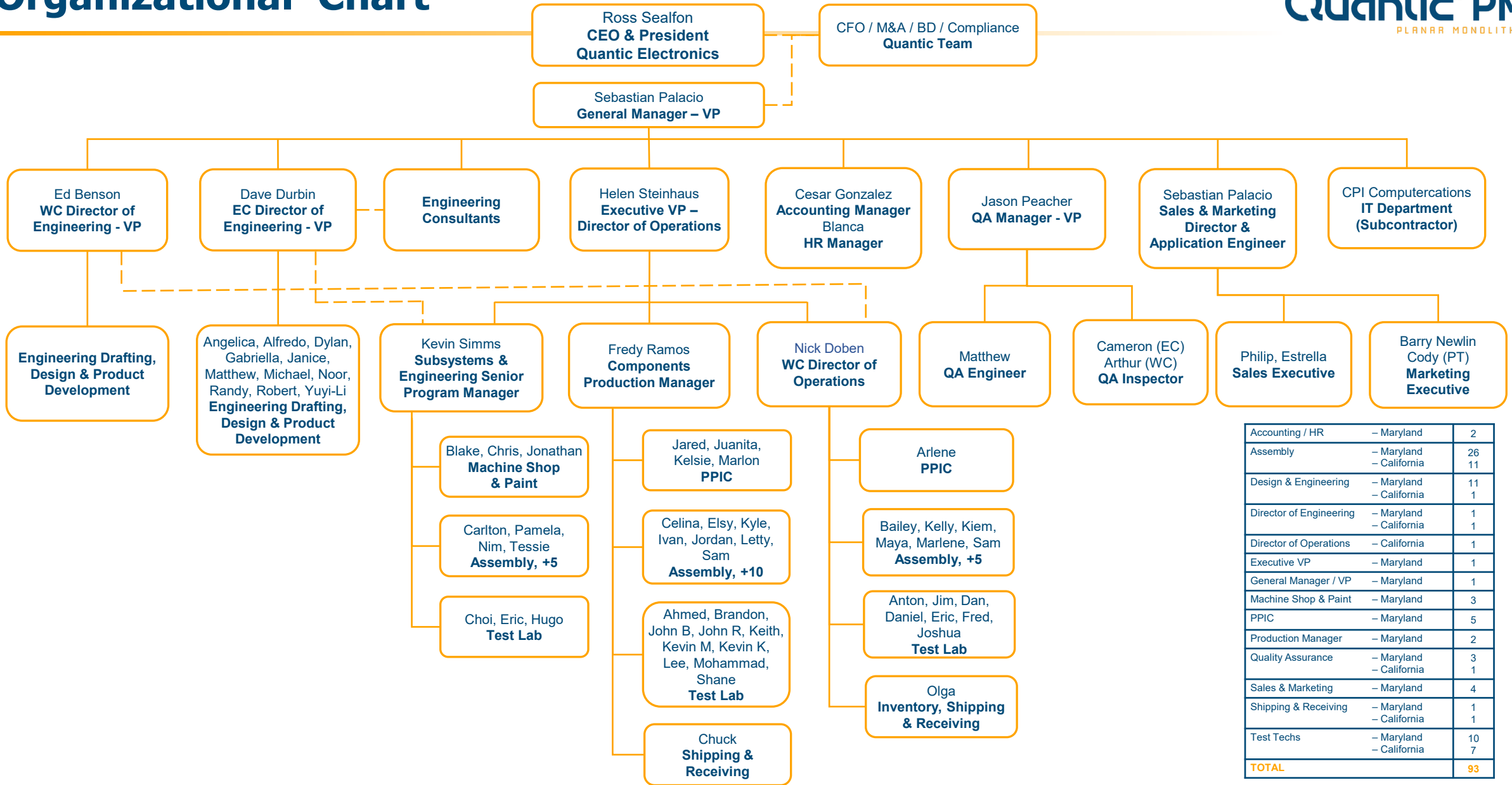

Accounting / HR	- Maryland	2
Assembly	- Maryland - California	26 11
Design & Engineering	- Maryland - California	11 1
Director of Engineering	- Maryland - California	1 1
Director of Operations	- California	1
Executive VP	- Maryland	1
General Manager / VP	- Maryland	1
Machine Shop & Paint	- Maryland	3
PPIC	- Maryland	5
Production Manager	- Maryland	2
Quality Assurance	- Maryland - California	3 1
Sales & Marketing	- Maryland	4
Shipping & Receiving	- Maryland - California	1 1
Test Techs	- Maryland - California	10 7
TOTAL		93

Thank You!

